



Vity's
DESIGN



Vity's Collection

From the incredible passion for HARLEY DAVIDSON, takes shape my every single "iron." From a deep and meticulous study of materials, shapes and color, arise my accessories. I love to see them shine, I love to touch them and I always hope that all the love that I put into their design and construction is transmitted to you, my friends, who share with me a passion for the wind in your hair and that, at least when you're on your motorbike.

Vital. Modes







BRAKE MASTER CYLINDER MATTHEW

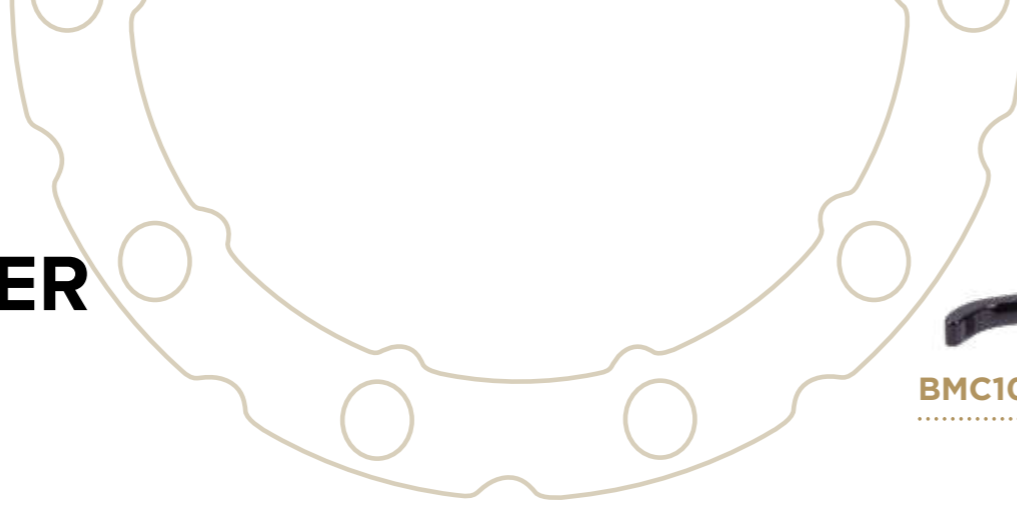

CNC Machined from billet aluminum and the compact size, is right for all handlebars 1".

Available in a many combinations of colors: black anodized - raw - brass - gold plated.

FEATURES:

- 5 axis CNC machined from billet aluminum
- Various finishings
- Easy to install
- Made in Italy
- Single Disc 9/16" (14,28 mm)
- Double Disc 11/16" (17,50 mm)

BMC101BLA	BRAKE MASTER CYLINDER FULL BLACK - 1 DISC
BMC102BLA	BRAKE MASTER CYLINDER FULL BLACK - 2 DISC
BMC101CUT	BRAKE MASTER CYLINDER BLACK CONTRAST CUT - 1 DISC
BMC102CUT	BRAKE MASTER CYLINDER BLACK CONTRAST CUT - 2 DISC
BMC101BPP	BRAKE MASTER CYLINDER BLACK - TANK POLISHED - LEVER POLISHED - 1 DISC
BMC102BPP	BRAKE MASTER CYLINDER BLACK - TANK POLISHED - LEVER POLISHED - 2 DISC
BMC101BBR	BRAKE MASTER CYLINDER BLACK - TANK BRASS - LEVER BRASS . 1 DISC
BMC102BBR	BRAKE MASTER CYLINDER BLACK - TANK BRASS - LEVER BRASS . 2 DISC
BMC101POL	BRAKE MASTER CYLINDER FULL POLISHED - 1 DISC
BMC102POL	BRAKE MASTER CYLINDER FULL POLISHED - 2 DISC
BMC101CHR	BRAKE MASTER CYLINDER FULL CHROME - 1 DISC
BMC102CHR	BRAKE MASTER CYLINDER FULL CHROME - 2 DISC
BMC101SAT	BRAKE MASTER CYLINDER FULL SATIN- 1 DISC
BMC102SAT	BRAKE MASTER CYLINDER FULL SATIN- 2 DISC
BMC101PBR	BRAKE MASTER CYLINDER POLISHED - TANK BRASS - LEVER BRASS - 1 DISC
BMC102PBR	BRAKE MASTER CYLINDER POLISHED - TANK BRASS - LEVER BRASS - 2 DISC
STS001M10	STOP LIGHT SWITCH M10 X 1,25 WITH BANJO BOLT



BMC101BLA



BMC101CUT



BMC101BPP



BMC101BBR



BMC101POL



BMC101CHR



BMC101SAT



STS001M10



BMC101PBR



BRAKE MASTER CYLINDER DIAMOND TANK

CNC Machined from billet aluminum and the compact size, is right for all handlebars 1".

Available in a many combinations of colors: black anodized - raw - brass - gold plated.

FEATURES:

- 5 axis CNC machined from billet aluminum
- Various finishings
- Easy to install
- Made in Italy
- Single Disc 9/16" (14,28 mm)
- Double Disc 11/16" (17,50 mm)

BMC001BLA	BRAKE MASTER CYLINDER FULL BLACK - 1 DISC
BMC002BLA	BRAKE MASTER CYLINDER FULL BLACK - 2 DISC
BMC001BPP	BRAKE MASTER CYLINDER BLACK - TANK POLISHED - LEVER POLISHED . 1 DISC
BMC002BPP	BRAKE MASTER CYLINDER BLACK - TANK POLISHED - LEVER POLISHED . 2 DISC
BMC001BBR	BRAKE MASTER CYLINDER BLACK - TANK BRASS - LEVER BRASS . 1 DISC
BMC002BBR	BRAKE MASTER CYLINDER BLACK - TANK BRASS - LEVER BRASS . 2 DISC
BMC001POL	BRAKE MASTER CYLINDER FULL POLISHED - 1 DISC
BMC002POL	BRAKE MASTER CYLINDER FULL POLISHED - 2 DISC
BMC001CHR	BRAKE MASTER CYLINDER FULL CHROME - 1 DISC
BMC002CHR	BRAKE MASTER CYLINDER FULL CHROME - 2 DISC
BMC001PBR	BRAKE MASTER CYLINDER POLISHED - TANK BRASS - LEVER BRASS . 1 DISC
BMC002PBR	BRAKE MASTER CYLINDER POLISHED - TANK BRASS - LEVER BRASS . 2 DISC
STS001M10	STOP LIGHT SWITCH M10 X 1,25 WITH BANJO BOLT



BMC001BLA



BMC001BPP



BMC001BBR



BMC001POL



BMC001CHR



BMC001PBR



STS001M10

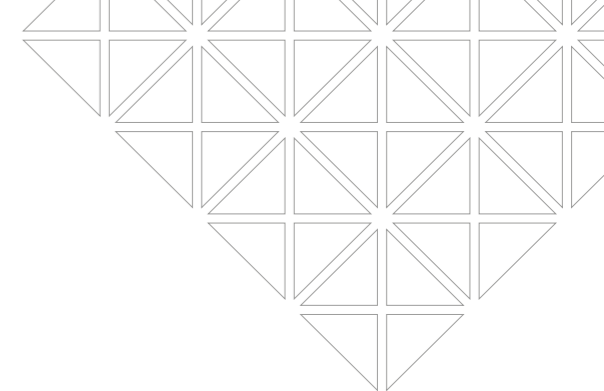



BRAKE MASTER CYLINDER DIAMOND SLIM

CNC Machined from billet aluminum and the compact size, is right for all handlebars 1".

Available in a many combinations of colors: black anodized - raw - brass - gold plated.

FEATURES:

- 5 axis CNC machined from billet aluminum
- Various finishings
- Easy to install
- Made in Italy
- Single Disc 9/16" (14,28 mm)
- Double Disc 11/16" (17,50 mm)

DBMC01BLA	DIAMOND BRAKE MASTER CYLINDER FULL BLACK - 1 DISC
DBMC02BLA	DIAMOND BRAKE MASTER CYLINDER FULL BLACK - 2 DISC
DBMC01BPP	DIAMOND BRAKE MASTER CYLINDER BLACK - CAP POLISHED - LEVER POLISHED . 1 DISC
DBMC02BPP	DIAMOND BRAKE MASTER CYLINDER BLACK - CAP POLISHED - LEVER POLISHED . 2 DISC
DBMC01BBR	DIAMOND BRAKE MASTER CYLINDER BLACK - TANK BRASS - LEVER BRASS . 1 DISC
DBMC02BBR	DIAMOND BRAKE MASTER CYLINDER BLACK - TANK BRASS - LEVER BRASS . 2 DISC
DBMC01POL	DIAMOND BRAKE MASTER CYLINDER FULL POLISHED - 1 DISC
DBMC02POL	DIAMOND BRAKE MASTER CYLINDER FULL POLISHED - 2 DISC
DBMC01CHR	DIAMOND BRAKE MASTER CYLINDER FULL CHROME - 1 DISC
DBMC02CHR	DIAMOND BRAKE MASTER CYLINDER FULL CHROME - 2 DISC
DBMC01PBR	DIAMOND BRAKE MASTER CYLINDER POLISHED - TANK BRASS - LEVER BRASS . 1 DISC
DBMC02PBR	DIAMOND BRAKE MASTER CYLINDER POLISHED - TANK BRASS - LEVER BRASS . 2 DISC
STS001M10	STOP LIGHT SWITCH M10 X 1,25 WITH BANJO BOLT



DBMC01BLA



DBMC01BBR



DBMC01CHR



STS001M10



DBMC01BPP



DBMC01POL



DBMC01PBR



HYDRAULIC CLUTCH MATTHEW

CNC Machined from billet aluminum and the compact size, is right for all handlebars 1".

Available in a many combinations of colors: black anodized - raw - brass - gold plated.

FEATURES:

- 5 axis Cnc machined from billet aluminum
- Various finishings
- Easy to install
- Made in Italy

HC0002BLA	HYDRAULIC CLUTCH FULL BLACK
HC0002CUT	HYDRAULIC CLUTCH BLACK CONTRAST CUT
HC0002BPP	HYDRAULIC CLUTCH BLACK - TANK POLISHED - LEVER POLISHED
HC0002BBR	HYDRAULIC CLUTCH BLACK - TANK BRASS - LEVER BRASS
HC0002POL	HYDRAULIC CLUTCH FULL POLISHED
HC0002CHR	HYDRAULIC CLUTCH FULL CHROME
HC0002SAT	HYDRAULIC CLUTCH FULL SATIN
HC0002PBR	HYDRAULIC CLUTCH POLISHED - TANK BRASS - LEVER BRASS



HC0002BLA



HC0002CUT



HC0002BPP



HC0002BBR



HC0002POL



HC0002CHR



HC0002SAT



HC0002PBR

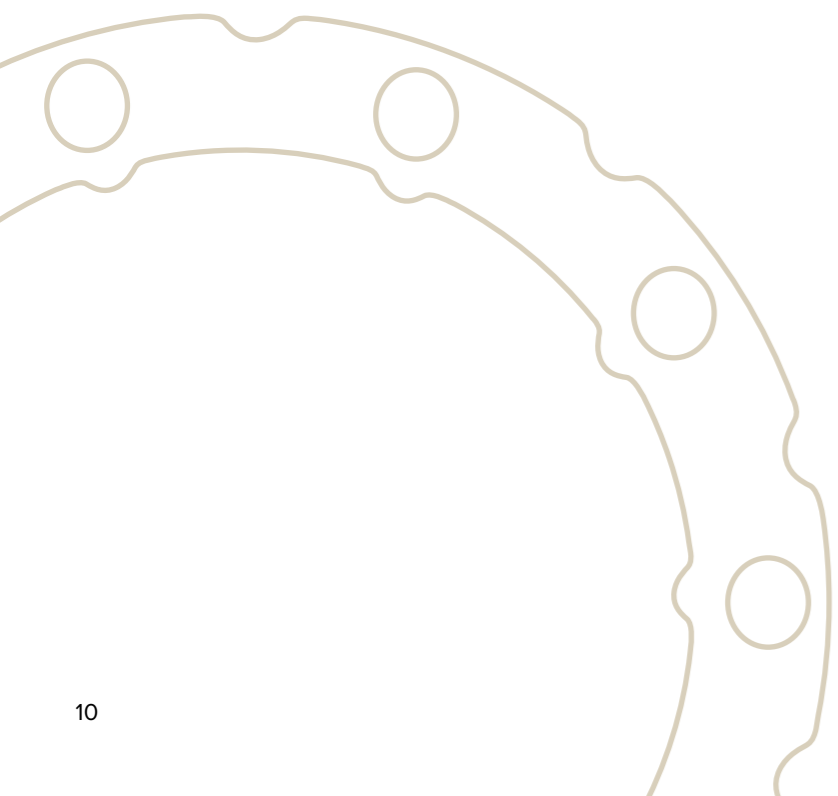

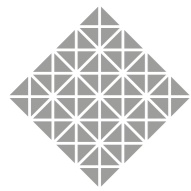

HYDRAULIC CLUTCH DIAMOND TANK

CNC Machined from billet aluminum and the compact size, is right for all handlebars 1".

Available in a many combinations of colors: black anodized - raw - brass - gold plated.

FEATURES:

- 5 axis CNC machined from billet aluminum
- Various finishings
- Easy to install
- Made in Italy
- Single Disc 9/16" (14,28 mm)
- Double Disc 11/16" (17,50 mm)

HC0001BLA	DIAMOND HYDRAULIC CLUTCH FULL BLACK
HC0001BPP	DIAMOND HYDRAULIC CLUTCH BLACK - TANK POLISHED - LEVER POLISHED
HC0001BBR	DIAMOND HYDRAULIC CLUTCH BLACK - TANK BRASS - LEVER BRASS
HC0001POL	DIAMOND HYDRAULIC CLUTCH FULL POLISHED
HC0001CHR	DIAMOND HYDRAULIC CLUTCH FULL CHROME
HC0001PBR	DIAMOND HYDRAULIC CLUTCH POLISHED - TANK BRASS - LEVER BRASS



HC0001BLA



HC0001BPP



HC0001BBR



HC0001POL



HC0001CHR



HC0001PBR

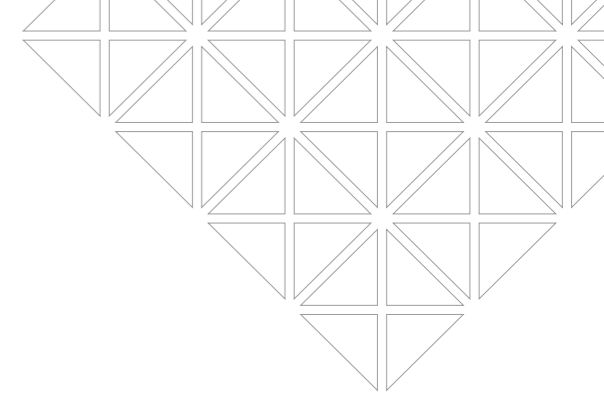

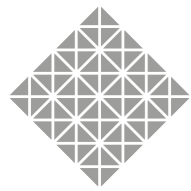

HYDRAULIC CLUTCH DIAMOND SLIM

CNC Machined from billet aluminum and the compact size, is right for all handlebars 1".

Available in a many combinations of colors: black anodized - raw - brass - gold plated.

FEATURES:

- 5 axis CNC machined from billet aluminum
- Various finishings
- Easy to install
- Made in Italy
- Single Disc 9/16" (14,28 mm)
- Double Disc 11/16" (17,50 mm)

DHC001BLA	DIAMOND HYDRAULIC CLUTCH FULL BLACK
DHC001BPP	DIAMOND HYDRAULIC CLUTCH BLACK - TANK POLISHED - LEVER POLISHED
DHC001BBR	DIAMOND HYDRAULIC CLUTCH BLACK - TANK BRASS - LEVER BRASS
DHC001POL	DIAMOND HYDRAULIC CLUTCH FULL POLISHED
DHC001CHR	DIAMOND HYDRAULIC CLUTCH FULL CHROME
DHC001PBR	DIAMOND HYDRAULIC CLUTCH POLISHED - TANK BRASS - LEVER BRASS



DHC001BLA



DHC001BPP



DHC001BBR



DHC001POL



DHC001CHR



DHC001PBR

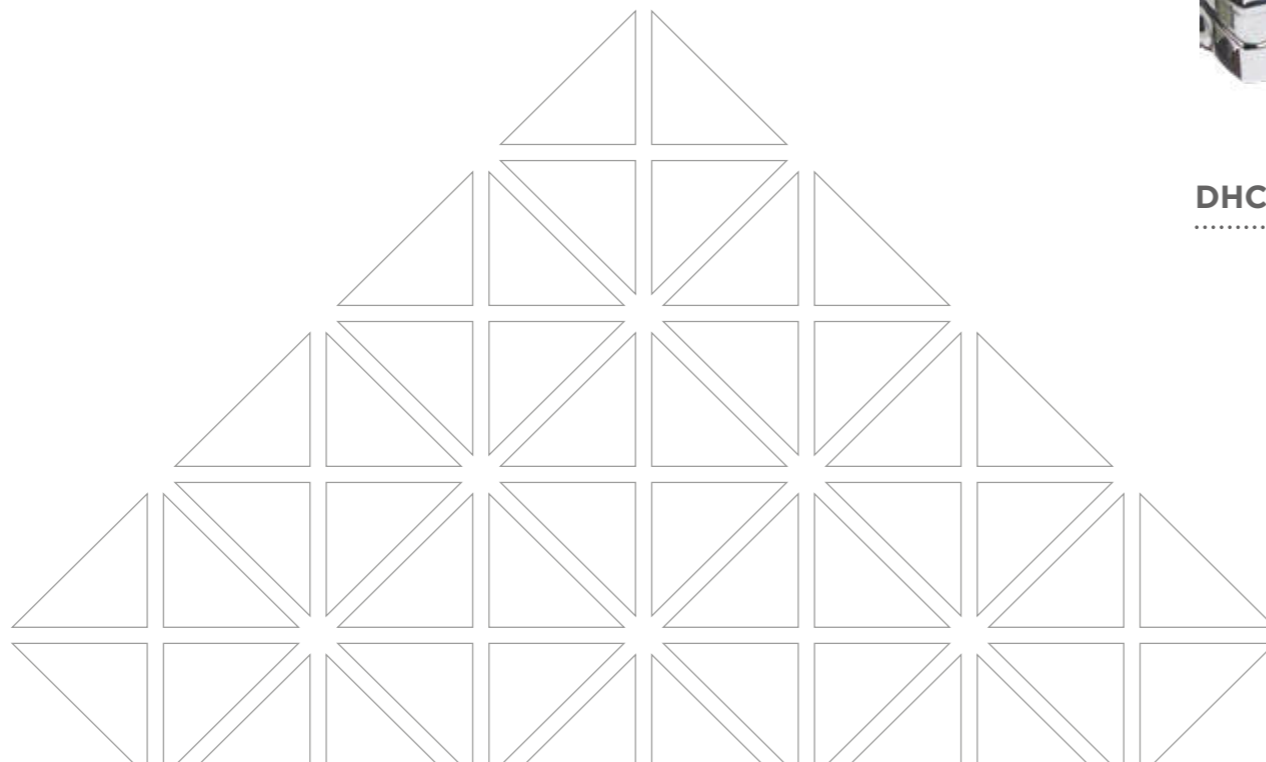



CABLE CLUTCH

CNC Machined from billet aluminum. The compact size, is right for all handlebars 1 ". Perfectly matching when to assemble the our brake master cylinder Matthew.

Available in a many combinations of colors: black anodized - raw - brass - gold plated.

FEATURES:

- 5 axis CNC Machined from billet aluminum
- Various finishings
- Easy to install
- Made in Italy

CC0001BLA	CABLE CLUTCH FULL BLACK
CC0001BPP	CABLE CLUTCH BLACK LEVER POLISHED
CC0001BBR	CABLE CLUTCH BLACK LEVER BRASS
CC0001POL	CABLE CLUTCH FULL POLISHED
CC0001CHR	CABLE CLUTCH FULL CHROME
CC0001SAT	CABLE CLUTCH FULL SATIN
CC0001PBR	CABLE CLUTCH POLISHED LEVER BRASS



CC0001BLA



CC0001BPP



CC0001BBR



CC0001POL



CC0001CHR



CC0001SAT



CC0001PBR

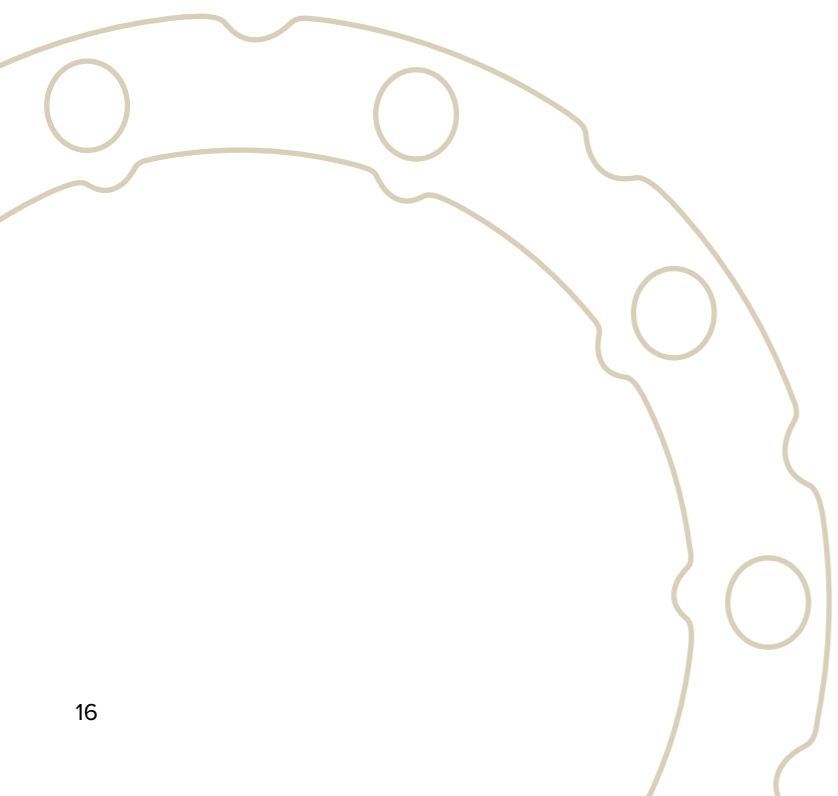



SWITCH HOUSINGS

CNC Machined from billet aluminum and brass are available in a many combinations of colors: black anodized - raw - brass - gold plated.

This Switch Housings are a perfect complement to our Master Cylinder.

FEATURES:

- 5 axis CNC Machined from billet aluminum or brass
- Various finishings
- Easy to install
- Made in Italy
- High Quality product
- Inox Switch

SW001BLA	SWITCH HOUSINGS BLACK LEFT
SW001RBLA	SWITCH HOUSINGS BLACK RIGHT
SW001LBRA	SWITCH HOUSINGS BRASS LEFT
SW001RBRA	SWITCH HOUSINGS BRASS RIGHT
SW001LSAT	SWITCH HOUSINGS SATIN LEFT
SW001RSAT	SWITCH HOUSINGS SATIN RIGHT
SW001LPOL	SWITCH HOUSINGS POLISHED LEFT
SW001RPOL	SWITCH HOUSINGS POLISHED RIGHT
SW001LCHR	SWITCH HOUSINGS CHROME LEFT
SW001RCHR	SWITCH HOUSINGS CHROME RIGHT



SW001BLA



SW001LBRA



SW001LSAT



SW001LCHR



SW001LPOL



SPACER HANDLEBAR

CNC Machined from billet aluminum and brass are available in a many combinations of colors: black anodized - raw - brass – gold plated.

This product complete our Hand Controls Collection and fit our switches housings.

FEATURES:

- 5 axis CNC Machined from billet aluminum or brass
- Various finishings
- Easy to install
- Made in Italy
- High Quality product

DIMENSIONS:

- Diameter 1.5"
- Length 3"

SH001BLA	SPACE HANDLEBAR BLACK LEFT
SH001RBLA	SPACE HANDLEBAR BLACK RIGHT
SH001LSAT	SPACE HANDLEBAR SATIN LEFT
SH001RSAT	SPACE HANDLEBAR SATIN RIGHT
SH001LPOL	SPACE HANDLEBAR POLISHED LEFT
SH001RPOL	SPACE HANDLEBAR POLISHED RIGHT
SH001LCHR	SPACE HANDLEBAR CHROME LEFT
SH001RCHR	SPACE HANDLEBAR CHROME RIGHT



SH001BLA



SH001LPOL



SH001LCHR



GRIPS

CNC Machined from billet aluminum or brass. Compact size, provided by a silicone rubber they ensure a secure grip and maximum comfort. High quality rubber from U.S.A. Suitable for all H-D models.

Available in a many combinations of colors: black anodized - raw - brass - gold plated.

FITTING:

- Only in a throttle cable.

FEATURES:

- CNC Machined from billet aluminum or brass
- Various finishings
- Easy to install
- Made in Italy

MGR001BLA	GRIPS BLACK
MGR001BRA	GRIPS BRASS
MGR001POL	GRIPS POLISHED
MGR001CHR	GRIPS CHROME
MGR00124K	GRIPS FULL GOLD PLATED 24 KT



MGR001BRA



MGR001BRA



MGR001CHR



MGR001POL



MGR00124K





FORWARD CONTROLS

CNC Machined from billet aluminum and brass are available in a many combinations of colors: black anodized - raw - brass - gold plated.

To make precious our products we are fitting 12 gems different from one another.

It matches perfectly with your handlebar Matthew Collection commands.

Available for HARLEY-DAVIDSON SOFTAIL Bolts included.

FITTING:

- Only in Harley Davidson Softail 00-17.

FEATURES:

- 5 axis CNC Machined from billet aluminum or brass
- Various finishings
- Easy to install
- Made in Italy
- High Quality product
- 11/16 Bore

MFC001BLA	FORWARD CONTROLS FULL BLACK
MFC001POL	FORWARD CONTROLS FULL POLISHED
MFC001CHR	FORWARD CONTROLS FULL CHROME
MFC001BBR	FORWARD CONTROLS BLACK AND BRASS GEMS
MFC001PBR	FORWARD CONTROLS POLISHED AND BRASS GEMS



MFC001BBR



MFC001PBR



SHIFT RODS

CNC Machined from billet aluminum and brass are available in a many combinations of colors: black anodized - raw - brass - gold plated.

To make precious our products we are fitting 3 gems different from one another.

FEATURES:

- 5 axis CNC Machined from billet aluminum or brass
- Various finishings
- Easy to install
- Made in Italy
- High Quality product
- Available HARLEY-DAVIDSON 86-18 Softail FXS, FXST, FLS, FLST, 84-18 FLT/Touring

MSR001BLA	SHIFT ROD FULL BLACK
MSR001POL	SHIFT ROD FULL POLISHED
MSR001CHR	SHIFT ROD FULL CHROME
MSR001BRA	SHIFT ROD BLACK AND BRASS GEMS
MSR001PBR	SHIFT ROD POLISHED AND BRASS GEMS

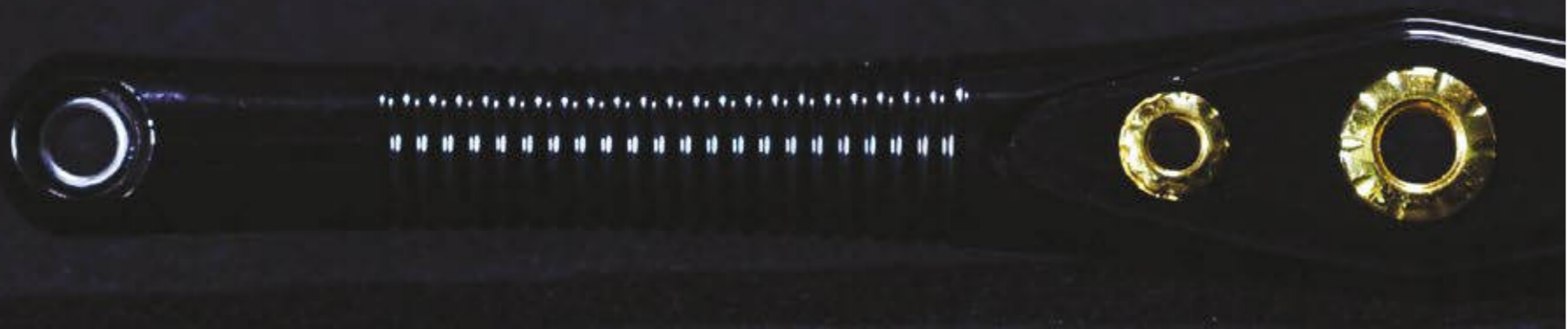

MSR001BRA



MSR001PBR



PEGS

CNC Machined from billet aluminum or brass, They are very comfortable with the grip of shoes. They are made to please 3 combinations: central, back, passenger.

All this thanks to the fastening system pegs / pivot tube. Made from stainless.

Available in a many combinations of colors: black anodized - raw - brass - gold plated.

FEATURES:

- Cnc machined from billet aluminum or brass
- Various finishings
- Easy to install
- Made in Italy

SHARIF FOOTPEGS

SPEG01BLA	FOOTPEGS BLACK
SPEG01BRA	FOOTPEGS BRASS
SPEG01POL	FOOTPEGS POLISHED
SPEG01CHR	FOOTPEGS CHROME
SPEG0124K	FOOTPEGS FULL GOLD PLATED 24 KT

DIMENSIONS:

- Diameter 1"
- Lenght 3,5"

SHARIF SHIFT / BRAKE PEG

SSFT01BLA	SHIFT / BRAKE PEG BLACK
SSFT01BRA	SHIFT / BRAKE PEG BRASS
SSFT01POL	SHIFT / BRAKE PEG POLISHED
SSFT01CHR	SHIFT / BRAKE PEG CHROME
SSFT0124K	SHIFT / BRAKE FULL GOLD PLATED 24 KT

DIMENSIONS:

- Diameter 0.9"
- Lenght 2"



SPEG01BLA



SSFT01BLA



SPEG01BRA



SSFT01BRA



SPEG01POL



SSFT01POL



SPEG01CHR



SSFT01CHR



SPEG0124K



SSFT0124K





JUICER HEADLIGHT

CNC Machined from billet aluminum and brass are available in a many combinations of colors: black anodized - raw - brass - gold plated.

Provided by a 4" lens.

FEATURES:

- 5 axis CNC Machined from billet aluminum
- Various finishings
- Easy to install
- Made in Italy

DIMENSIONS:

- Diameter 5.26"
- Length 4.70"

JHL001BLA	JUICER HEADLIGHT FULL BLACK
JHL001BPO	JUICER HEADLIGHT BLACK RING POLISHED
JHL001BBR	JUICER HEADLIGHT BLACK RING BRASS
JHL001POL	JUICER HEADLIGHT FULL POLISHED
JHL001CHR	JUICER HEADLIGHT FULL CHROME
JHL001SAT	JUICER HEADLIGHT SATIN RING SATIN
JHL001PBR	JUICER HEADLIGHT POLISHED RING BRASS
JHL00124K	JUICER HEADLIGHT FULL GOLD PLATED 24 KT



JHL001BLA



JHL001BPO



JHL001BBR



JHL001POL



JHL001CHR



JHL001SAT



JHL001PBR



JHL00124K





TAILLIGHT

Cnc Machined from billet aluminum. Is provided by 15 high brightness LED strip.

Available in a many combinations of colors: black anodized - raw - brass - gold plated.

Thanks to a lot color combinations they could be used for a OLD STYLE / MODERN STYLE / HIGH TECH.

FEATURES:

- 5 axis Cnc machined from billet aluminum
- Various finishings
- Easy to install
- Made in Italy

DIMENSIONS:

- Diameter 2.56"
- Lenght 2.05"

JTL001BLA	JUICER SPOTLIGHT REAR LITTLE FULL BLACK
JTL001BPO	JUICER SPOTLIGHT REAR LITTLE BLACK RING POLISHED
JTL001BBR	JUICER SPOTLIGHT REAR LITTLE BLACK RING BRASS
JTL001POL	JUICER SPOTLIGHT REAR LITTLE FULL POLISHED
JTL001CHR	JUICER SPOTLIGHT REAR LITTLE FULL CHROME
JTL001SAT	JUICER SPOTLIGHT REAR LITTLE SATIN RING SATIN
JTL001SBR	JUICER SPOTLIGHT REAR LITTLE SATIN RING BRASS
JTL00124K	JUICER SPOTLIGHT REAR LITTLE FUL GOLD PLATED 24 KT



JTL001BLA



JTL001BPO



JTL001BBR



JTL001POL



JTL001CHR



JTL001SAT



JTL001SBR



JTL00124K





TURN SIGNAL

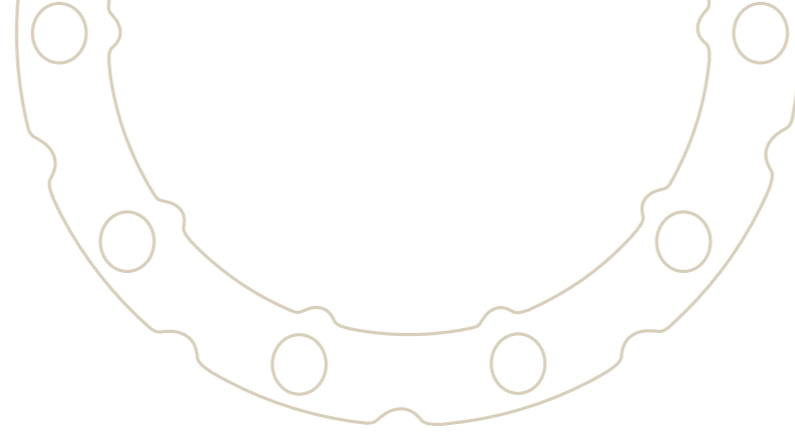

CNC Machined from billet aluminum and brass are available in a many combinations of colors: black anodized - raw - brass - gold plated.

Six High brightness LED integrated into the body, equipped with European approval. They could be used for a OLD STYLE / MODERN STYLE / HIGH TECH.

FEATURES:

- 5 axis CNC Machined from billet aluminum or brass
- Various finishings
- Easy to install
- Made in Italy
- High Quality product
- Six High brightness LED

DIMENSIONS:

- Diameter 1.18"
- Length 1.26"



JTS001BLA



JTS001BPO



JTS001BBR



JTS001POL



JTS001CHR



JTS001SAT



JTS001PBR



JTS00124K

JTS001BLA	JUICER TURN SIGNAL FULL BLACK
JTS001BPO	JUICER TURN SIGNAL BLACK RING POLISHED
JTS001BBR	JUICER TURN SIGNAL BLACK RING BRASS
JTS001POL	JUICER TURN SIGNAL FULL POLISHED
JTS001CHR	JUICER TURN SIGNAL FULL CHROME
JTS001SAT	JUICER TURN SIGNAL FULL SATIN
JTS001PBR	JUICER TURN SIGNAL POLISHED RING BRASS
JTS00124K	JUICER TURN SIGNAL FULL GOLD PLATED 24 KT





JUICER AIR CLEANER

CNC Machined from billet aluminum and brass are available in a many combinations of colors: black anodized - raw - brass - gold plated.

This filter completes our JUICER Collection that include Front Light - Taillight - Turn Signal. Inside include filter element K&N.

FEATURES:

- 5 axis CNC Machined from billet aluminum or brass
- Various finishings
- Easy to install
- Made in Italy
- High Quality product
- Filter Element K&N

JAIRO1BLA-S	JUICER AIRCLEANER FULL BLACK	91-15 XL
JAIRO1BLA-E	JUICER AIRCLEANER FULL BLACK	93-15 Big Twin
JAIRO1BLA-T	JUICER AIRCLEANER FULL BLACK	08-15 Touring (e-throttle)
JAIRO1BLA-F	JUICER AIRCLEANER FULL BLACK	2016 SOFTAIL (e-throttle)
JAIRO1BLA-M	JUICER AIRCLEANER FULL BLACK	Milwaukee 8 Engine
JAIRO1BBR-S	JUICER AIRCLEANER BLACK CAP BRASS	91-15 XL
JAIRO1BBR-E	JUICER AIRCLEANER BLACK CAP BRASS	93-15 Big Twin
JAIRO1BBR-T	JUICER AIRCLEANER BLACK CAP BRASS	08-15 Touring (e-throttle)
JAIRO1BBR-F	JUICER AIRCLEANER BLACK CAP BRASS	2016 SOFTAIL (e-throttle)
JAIRO1BBR-M	JUICER AIRCLEANER BLACK CAP BRASS	Milwaukee 8 Engine
JAIRO1POL-S	JUICER AIRCLEANER FULL POLISHED	91-15 XL
JAIRO1POL-E	JUICER AIRCLEANER FULL POLISHED	93-15 Big Twin
JAIRO1POL-T	JUICER AIRCLEANER FULL POLISHED	08-15 Touring (e-throttle)
JAIRO1POL-F	JUICER AIRCLEANER FULL POLISHED	2016 SOFTAIL (e-throttle)
JAIRO1POL-M	JUICER AIRCLEANER FULL POLISHED	Milwaukee 8 Engine
JAIRO1CHR-S	JUICER AIRCLEANER FULL CHROME	91-15 XL
JAIRO1CHR-E	JUICER AIRCLEANER FULL CHROME	93-15 Big Twin
JAIRO1CHR-T	JUICER AIRCLEANER FULL CHROME	08-15 Touring (e-throttle)
JAIRO1CHR-F	JUICER AIRCLEANER FULL CHROME	2016 SOFTAIL (e-throttle)
JAIRO1CHR-M	JUICER AIRCLEANER FULL CHROME	Milwaukee 8 Engine
JAIRO1SAT-S	JUICER AIRCLEANER FULL SATIN	91-15 XL
JAIRO1SAT-E	JUICER AIRCLEANER FULL SATIN	93-15 Big Twin
JAIRO1SAT-T	JUICER AIRCLEANER FULL SATIN	08-15 Touring (e-throttle)
JAIRO1SAT-F	JUICER AIRCLEANER FULL SATIN	2016 SOFTAIL (e-throttle)
JAIRO1SAT-M	JUICER AIRCLEANER FULL SATIN	Milwaukee 8 Engine
JAIRO1PBR-S	JUICER AIRCLEANER POLISHED CAP BRASS	91-15 XL
JAIRO1PBR-E	JUICER AIRCLEANER POLISHED CAP BRASS	93-15 Big Twin
JAIRO1PBR-T	JUICER AIRCLEANER POLISHED CAP BRASS	08-15 Touring (e-throttle)
JAIRO1PBR-F	JUICER AIRCLEANER POLISHED CAP BRASS	2016 SOFTAIL (e-throttle)
JAIRO1PBR-M	JUICER AIRCLEANER POLISHED CAP BRASS	Milwaukee 8 Engine
JAIRO124K-S	JUICER AIRCLEANER FULL GOLD PLATED 24 KT	91-15 XL
JAIRO124K-E	JUICER AIRCLEANER FULL GOLD PLATED 24 KT	93-15 Big Twin
JAIRO124K-T	JUICER AIRCLEANER FULL GOLD PLATED 24 KT	08-15 Touring (e-throttle)
JAIRO124K-F	JUICER AIRCLEANER FULL GOLD PLATED 24 KT	2016 SOFTAIL (e-throttle)
JAIRO124K-M	JUICER AIRCLEANER FULL GOLD PLATED 24 KT	Milwaukee 8 Engine



JAIRO1BLA



JAIRO1BBR



JAIRO1POL



JAIRO1CHR



JAIRO1SAT



JAIRO1PBR



JAIRO124K

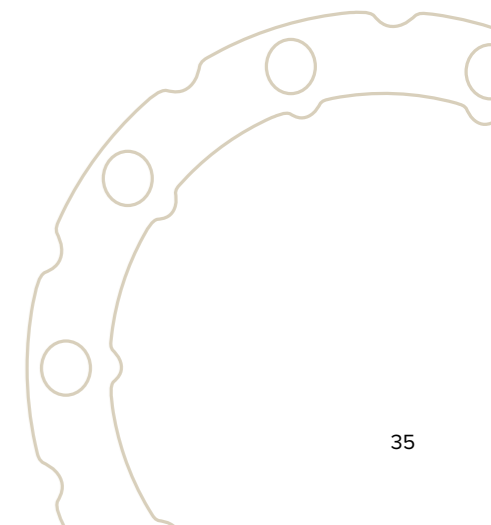



VELOCITY STACK CHALLENGER DESIGN

CNC Machined from billet aluminum. Sporty Design and elegant it's right for HIGH TECH motorbike and for model OLD STYLE.

Available in a many combinations of colors: black anodized - raw - brass - gold plated.

FEATURES:

- CNC Machined from billet aluminum
- Various finishings
- Easy to install
- Made in Italy

DIMENSIONS:

- Diameter 3.75"
- Lenght 4"

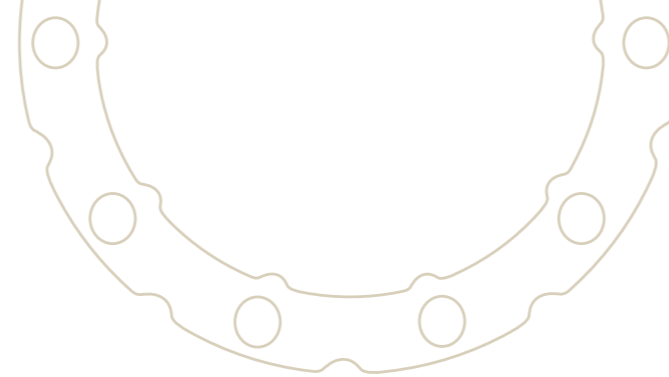

VSC001BLA



VSC001BBR

VSC001BLA-S	VELOCITY STACK FULL BLACK	91-15 XL
VSC001BLA-E	VELOCITY STACK FULL BLACK	93-15 Big Twin
VSC001BLA-T	VELOCITY STACK FULL BLACK	08-15 Touring (e-throttle)
VSC001BLA-F	VELOCITY STACK FULL BLACK	2016 SOFTAIL (e-throttle)
VSC001BBR-S	VELOCITY STACK BLACK CAP BRASS	91-15 XL
VSC001BBR-E	VELOCITY STACK BLACK CAP BRASS	93-15 Big Twin
VSC001BBR-T	VELOCITY STACK BLACK CAP BRASS	08-15 Touring (e-throttle)
VSC001BBR-F	VELOCITY STACK BLACK CAP BRASS	2016 SOFTAIL (e-throttle)
VSC001POL-S	VELOCITY STACK FULL POLISHED	91-15 XL
VSC001POL-E	VELOCITY STACK FULL POLISHED	93-15 Big Twin
VSC001POL-T	VELOCITY STACK FULL POLISHED	08-15 Touring (e-throttle)
VSC001POL-F	VELOCITY STACK FULL POLISHED	2016 SOFTAIL (e-throttle)
VSC001CHR-S	VELOCITY STACK FULL CHROME	91-15 XL
VSC001CHR-E	VELOCITY STACK FULL CHROME	93-15 Big Twin
VSC001CHR-T	VELOCITY STACK FULL CHROME	08-15 Touring (e-throttle)
VSC001CHR-F	VELOCITY STACK FULL CHROME	2016 SOFTAIL (e-throttle)
VSC001SAT-S	VELOCITY STACK FULL SATIN	91-15 XL
VSC001SAT-E	VELOCITY STACK FULL SATIN	93-15 Big Twin
VSC001SAT-T	VELOCITY STACK FULL SATIN	08-15 Touring (e-throttle)
VSC001SAT-F	VELOCITY STACK FULL SATIN	2016 SOFTAIL (e-throttle)
VSC001PBR-S	VELOCITY STACK POLISHED CAP BRASS	91-15 XL
VSC001PBR-E	VELOCITY STACK POLISHED CAP BRASS	93-15 Big Twin
VSC001PBR-T	VELOCITY STACK POLISHED CAP BRASS	08-15 Touring (e-throttle)
VSC001PBR-F	VELOCITY STACK POLISHED CAP BRASS	2016 SOFTAIL (e-throttle)
VSC00124K-S	VELOCITY STACK FULL GOLD PLATED 24 KT	91-15 XL
VSC00124K-E	VELOCITY STACK FULL GOLD PLATED 24 KT	93-15 Big Twin
VSC00124K-T	VELOCITY STACK FULL GOLD PLATED 24 KT	08-15 Touring (e-throttle)
VSC00124K-F	VELOCITY STACK FULL GOLD PLATED 24 KT	2016 SOFTAIL (e-throttle)



VSC001POL



VSC001CHR



VSC001PBR



VSC00124K





VELOCITY STACK CHALLENGER DESIGN MILWAUKEE 8 ENGINE

CNC Machined from billet aluminum. Sporty Design and elegant it's right for HIGH TECH motorbike and for model OLD STYLE.

Available in a many combinations of colors: black anodized - raw - brass - gold plated.

FEATURES:

- CNC Machined from billet aluminum
- Various finishings
- Easy to install
- Made in Italy

DIMENSIONS:

- Diameter 3.75"
- Length 4"

VSC001BLA-M	VELOCITY STACK FULL BLACK Milwaukee 8 Engine
VSC001BBR-M	VELOCITY STACK BLACK CAP BRASS Milwaukee 8 Engine
VSC001POL-M	VELOCITY STACK FULL POLISHED Milwaukee 8 Engine
VSC001CHR-M	VELOCITY STACK FULL CHROME Milwaukee 8 Engine
VSC001PBR-M	VELOCITY STACK POLISHED CAP BRASS Milwaukee 8 Engine



VSC001BLA-M



VSC001BBR-M



VSC001POL-M



VSC001CHR-M



VSC001PBR-M

THROTTLE SERVO COVER MILWAUKEE 8 ENGINE



TSC001BLA



TSC001POL



TSC001CHR

TSC001BLA	THROTTLE SERVO COVER BLACK Milwaukee 8 Engine
TSC001POL	THROTTLE SERVO COVER POLISHED Milwaukee 8 Engine
TSC001CHR	THROTTLE SERVO COVER CHROME Milwaukee 8 Engine

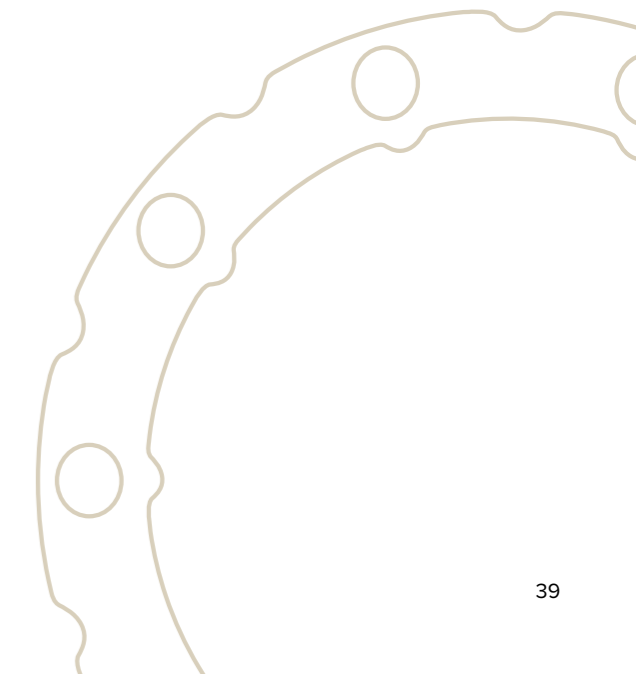



VELOCITY STACK GRILL DESIGN

CNC Machined from billet aluminum. Sporty Design and elegant it's right for HIGH TECH motorbike and for model OLD STYLE.

Available in a many combinations of colors: black anodized - raw - brass - gold plated.

FEATURES:

- CNC Machined from billet aluminum
- Various finishings
- Easy to install
- Made in Italy

DIMENSIONS:

- Diameter 3.75"
- Length 4"

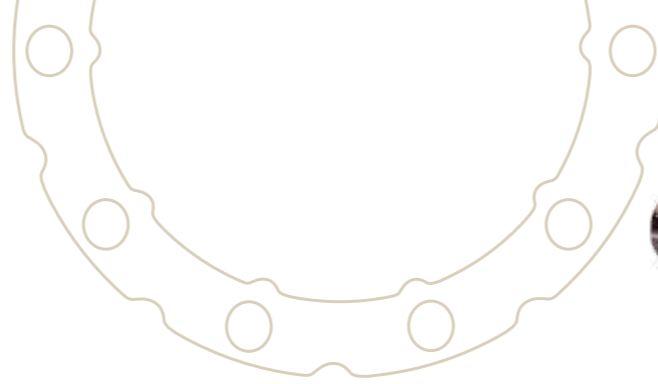

VSC003BLA



VSC003BBR

VSC003BLA-S	VELOCITY STACK FULL BLACK	91-15 XL
VSC003BLA-E	VELOCITY STACK FULL BLACK	93-15 Big Twin
VSC003BLA-T	VELOCITY STACK FULL BLACK	08-15 Touring (e-throttle)
VSC003BLA-F	VELOCITY STACK FULL BLACK	2016 SOFTAIL (e-throttle)
VSC003BBR-S	VELOCITY STACK BLACK CAP BRASS	91-15 XL
VSC003BBR-E	VELOCITY STACK BLACK CAP BRASS	93-15 Big Twin
VSC003BBR-T	VELOCITY STACK BLACK CAP BRASS	08-15 Touring (e-throttle)
VSC003BBR-F	VELOCITY STACK BLACK CAP BRASS	2016 SOFTAIL (e-throttle)
VSC003POL-S	VELOCITY STACK FULL POLISHED	91-15 XL
VSC003POL-E	VELOCITY STACK FULL POLISHED	93-15 Big Twin
VSC003POL-T	VELOCITY STACK FULL POLISHED	08-15 Touring (e-throttle)
VSC003POL-F	VELOCITY STACK FULL POLISHED	2016 SOFTAIL (e-throttle)
VSC003CHR-S	VELOCITY STACK FULL CHROME	91-15 XL
VSC003CHR-E	VELOCITY STACK FULL CHROME	93-15 Big Twin
VSC003CHR-T	VELOCITY STACK FULL CHROME	08-15 Touring (e-throttle)
VSC003CHR-F	VELOCITY STACK FULL CHROME	2016 SOFTAIL (e-throttle)
VSC003SAT-S	VELOCITY STACK FULL SATIN	91-15 XL
VSC003SAT-E	VELOCITY STACK FULL SATIN	93-15 Big Twin
VSC003SAT-T	VELOCITY STACK FULL SATIN	08-15 Touring (e-throttle)
VSC003SAT-F	VELOCITY STACK FULL SATIN	2016 SOFTAIL (e-throttle)
VSC003PBR-S	VELOCITY STACK POLISHED CAP BRASS	91-15 XL
VSC003PBR-E	VELOCITY STACK POLISHED CAP BRASS	93-15 Big Twin
VSC003PBR-T	VELOCITY STACK POLISHED CAP BRASS	08-15 Touring (e-throttle)
VSC003PBR-F	VELOCITY STACK POLISHED CAP BRASS	2016 SOFTAIL (e-throttle)
VSC00324K-S	VELOCITY STACK FULL GOLD PLATED 24 KT	91-15 XL
VSC00324K-E	VELOCITY STACK FULL GOLD PLATED 24 KT	93-15 Big Twin
VSC00324K-T	VELOCITY STACK FULL GOLD PLATED 24 KT	08-15 Touring (e-throttle)
VSC00324K-F	VELOCITY STACK FULL GOLD PLATED 24 KT	2016 SOFTAIL (e-throttle)



VSC003POL



VSC003CHR



VSC003PBR



VSC00324K





VELOCITY STACK CHALLENGER DESIGN MILWAUKEE 8 ENGINE

CNC Machined from billet aluminum. Sporty Design and elegant it's right for HIGH TECH motorbike and for model OLD STYLE.

Available in a many combinations of colors: black anodized - raw - brass - gold plated.

FEATURES:

- CNC Machined from billet aluminum
- Various finishings
- Easy to install
- Made in Italy

DIMENSIONS:

- Diameter 3.75"
- Length 4"

VSC003BLA-M	VELOCITY STACK FULL BLACK Milwaukee 8 Engine
VSC003BBR-M	VELOCITY STACK BLACK CAP BRASS Milwaukee 8 Engine
VSC003POL-M	VELOCITY STACK FULL POLISHED Milwaukee 8 Engine
VSC003CHR-M	VELOCITY STACK FULL CHROME Milwaukee 8 Engine
VSC003PBR-M	VELOCITY STACK POLISHED CAP BRASS Milwaukee 8 Engine



VSC003BLA-M



VSC003BBR-M



VSC003POL-M



VSC003CHR-M



VSC003PBR-M

THROTTLE SERVO COVER MILWAUKEE 8 ENGINE



TSC001BLA



TSC001POL



TSC001CHR

TSC001BLA	THROTTLE SERVO COVER BLACK Milwaukee 8 Engine
TSC001POL	THROTTLE SERVO COVER POLISHED Milwaukee 8 Engine
TSC001CHR	THROTTLE SERVO COVER CHROME Milwaukee 8 Engine



GAS CAP

CNC Machined from billet aluminum or brass is ideal for all tank giving a special look.

Unique Design and made from billet aluminum or brass, gives your bike a beautiful look.

Available in a many combinations of colors: black anodized - raw - brass - gold plated.

FEATURES:

- CNC Machined from billet aluminum or brass
- Various finishings
- Easy to install
- High quality product
- Made in Italy
- **WITH VENT HOLE**

SHARIF GAS CAP

SGC001BLA	SHARIF GAS CAP BLACK
SGC001BRA	SHARIF GAS CAP BRASS
SGC001POL	SHARIF GAS CAP POLISHED
SGC001CHR	SHARIF GAS CAP CHROME
SGC00124K	SHARIF GAS CAP FULL GOLD PLATED 24 KT

GRILL GAS CAP

GGC001BLA	GRILL GAS CAP BLACK
GGC001BRA	GRILL GAS CAP BRASS
GGC001POL	GRILL GAS CAP POLISHED
GGC001CHR	GRILL GAS CAP CHROME
GGC00124K	GRILL GAS CAP FULL GOLD PLATED 24 KT



SGC001BLA



GGC001BLA



SGC001POL



GGC001POL



SGC001BRA



GGC001BRA

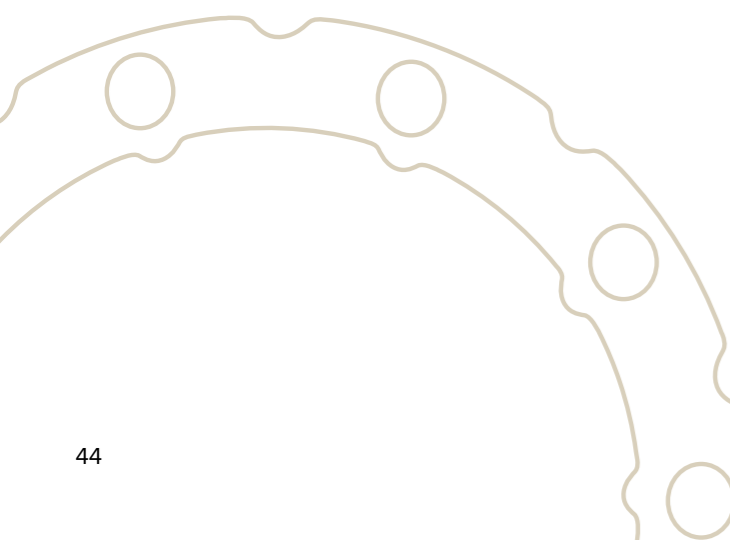



MIRRORS

CNC Machined from billet aluminum and brass are available in a many combinations of colors: black anodized - raw - brass - gold plated.

They could be used for a OLD STYLE / MODERN STYLE / HIGH TECH.

FEATURES:

- CNC Machined from billet aluminum or brass
- Various finishings
- Easy to install
- Made in Italy
- High Quality product
- Convex Glass

DIMENSIONS MIRROR:

- Diameter 2.83"

GM0001BLA	MIRROR BLACK BRACKET BLACK
GM0001BBR	MIRROR BRASS BRACKET BLACK
GM0001BPO	MIRROR POLISHED BRACKET BLACK
GM0001POL	MIRROR POLISHED BRACKET POLISHED
GM0001POB	MIRROR BLACK BRACKET POLISHED
GM0001CHR	MIRROR CHROME BRACKET CHROME
GM0001PBR	MIRROR BRAS BRACKET POLISHED
GM000124K	MIRROR FULL GOLD PLATED 24 KT



GM0001BLA



GM0001BBR



GM0001BPO



GM0001POL



GM0001POB



GM0001PBR



GM000124K

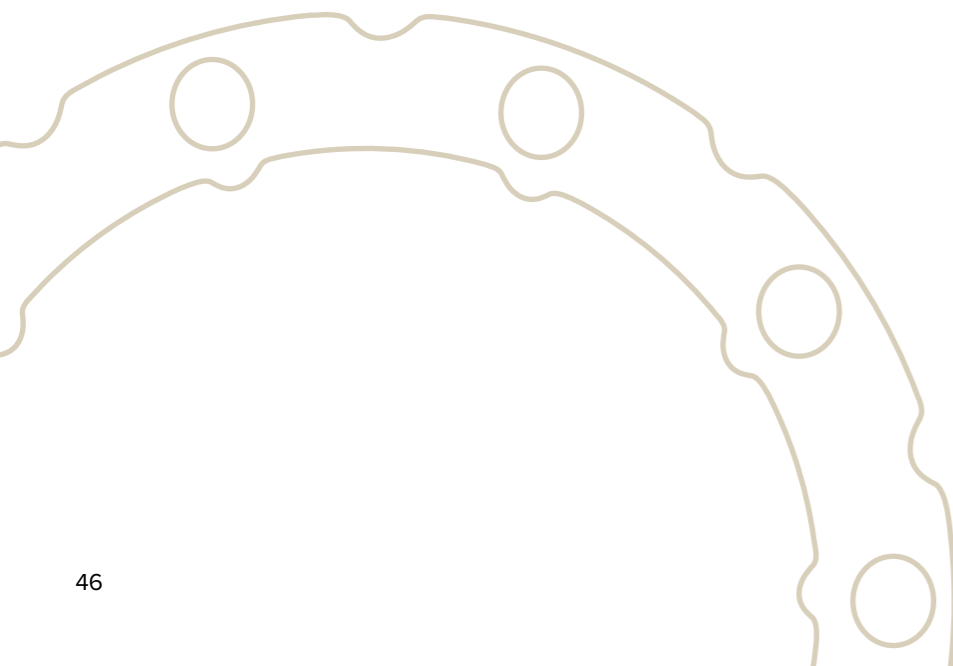



EXHAUST TIPS

From a simple billet piece of brass or aluminum we've done a work of art. Capable of transforming your exhaust into something unique.

From Brass or aluminum will be realized to your specifications diameter exhaust.

CNC Machined from billet aluminum and brass are available in a many combinations of colors: black anodized - raw - brass - gold plated.

FEATURES:

- CNC Machined from billet aluminum
- Various finishings
- Easy to install
- Made in Italy

SET001BLA	EXHAUST TIPS BLACK
SET001BRA	EXHAUST TIPS BRASS
SET001POL	EXHAUST TIPS POLISHED
SET001CHR	EXHAUST TIPS CHROME
SET00124K	EXHAUST TIPS GOLD PLATED 24 KT

PERSONALIZE YOUR EXHAUST TIPS

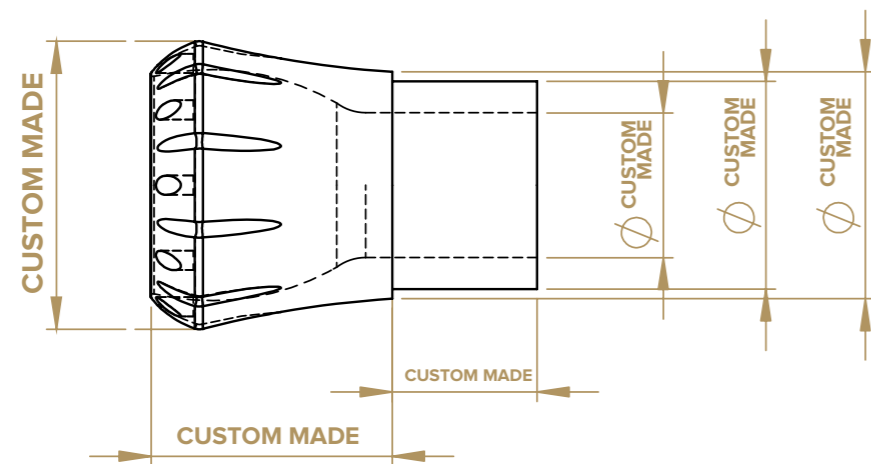

SET001BLA

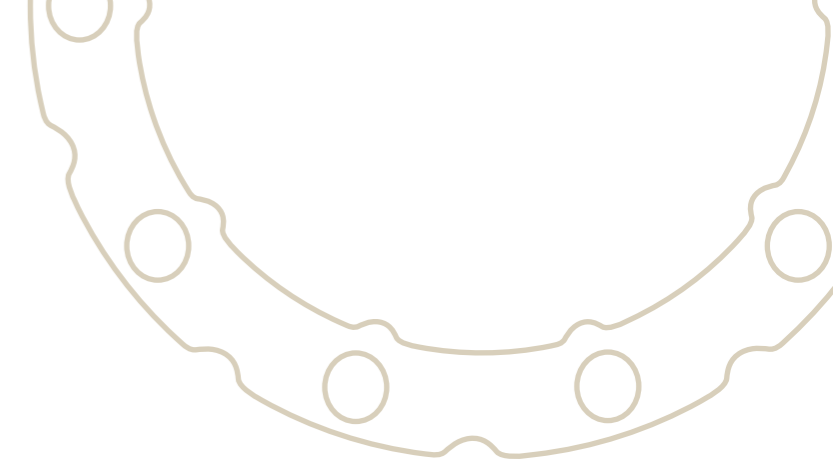

SET001BRA



SET001POL



SET001CHR



Vity's
DESIGN

Diamond Bagger Collection

Lovers of Italian fashion, inspired by the great stylists we were able to realize and create a new collection featuring a unique and exclusive design called "Diamond". With this collection we want to offer our customers a product that gives a new BAGGER concept, inspired by Italian tailoring to not go unnoticed. Assembled and checked by hand one by one to ensure a high quality product worthy of the best Made in Italy.

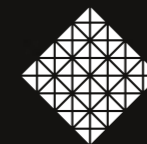

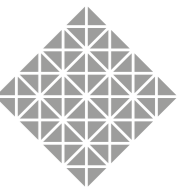
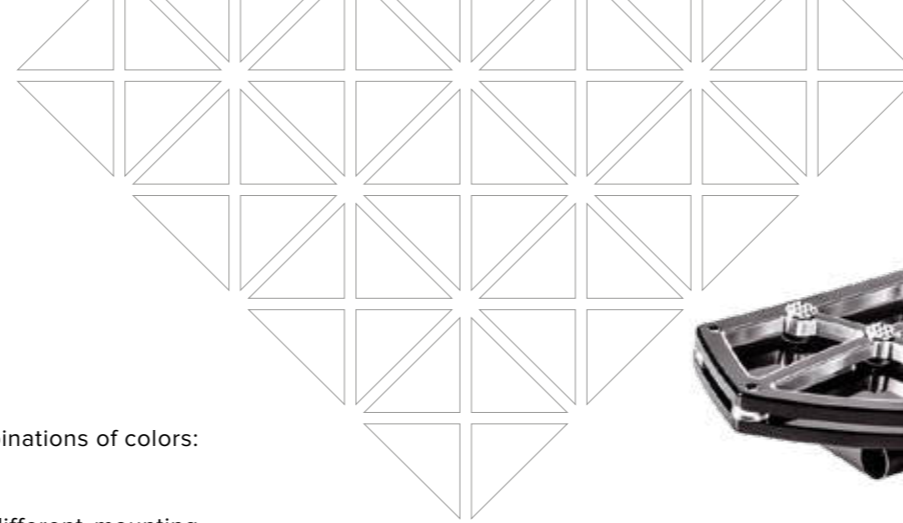
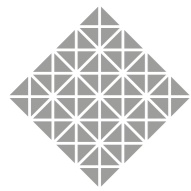

FLOORBOARD

CNC Machined from billet aluminum and brass are available in a many combinations of colors: black anodized raw - brass - gold plated.

18 DIAMOND Inserts provide a non-slip surface. These boards feature 2 different mounting locations allowing you to adjust the board to your preferred riding position.

FEATURES:

- CNC Machined from billet aluminum or brass
- Various finishings
- Easy to install
- Made in Italy
- High Quality product
- Fits all HARLEY-DAVIDSON HARLEY-DAVIDSON 1983-2018 FLST & 1993-2018 FL models

DIMENSIONS:

Driver Floorboards: 13.8" L x 5.0" W



 **DFLR01BLP**



DFLR01CHR 

DFLR01BLP	DIAMOND FRONT FLOORBOARD CONTRAST CUT WITH SKIDPROOF POLISHED
DFLR01CHR	DIAMOND FRONT FLOORBOARD FULL CHROME
DFLR01BBR	DIAMOND FRONT FLOORBOARD FULL BLACK WITH SKIDPROOF BRASS
DFLR01BLA	DIAMOND FRONT FLOORBOARD FULL BLACK WITH SKIDPROOF BLACK
DFLR01BBL	DIAMOND FRONT FLOORBOARD FULL BLACK WITH SKIDPROOF BLUE
DFLR01BGR	DIAMOND FRONT FLOORBOARD FULL BLACK WITH SKIDPROOF GREEN
DFLR01BRE	DIAMOND FRONT FLOORBOARD FULL BLACK WITH SKIDPROOF RED
DFLR01CBL	DIAMOND FRONT FLOORBOARD FULL CHROME WITH SKIDPROOF BLUE
DFLR01CGR	DIAMOND FRONT FLOORBOARD FULL CHROME WITH SKIDPROOF GREEN
DFLR01CRE	DIAMOND FRONT FLOORBOARD FULL CHROME WITH SKIDPROOF RED
DFLR01POL	DIAMOND FRONT FLOORBOARD FULL POLISHED WITH SKIDPROOF POLISHED
DFLR01WBR	DIAMOND FRONT FLOORBOARD FULL WHITE POWDER COAT WITH SKIDPROOF BRASS
DFLR0124K	DIAMOND FRONT FLOORBOARD FULL GOLD PLATED 24 KT



 **DFLR01BBR**



 **DFLR01BLA**



 **DFLR01BGR**



 **DFLR01BRE**



 **DFLR01CBL**



 **DFLR01CGR**



 **DFLR01CRE**



 **DFLR01POL**



 **DFLR01WBR**



 **DFLR0124K**



 **DFLR01CBL**



 **DFLR01CGR**



 **DFLR01CRE**

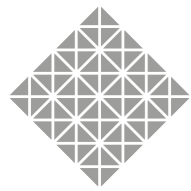

PASSENGER FLOORBOARD

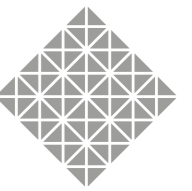
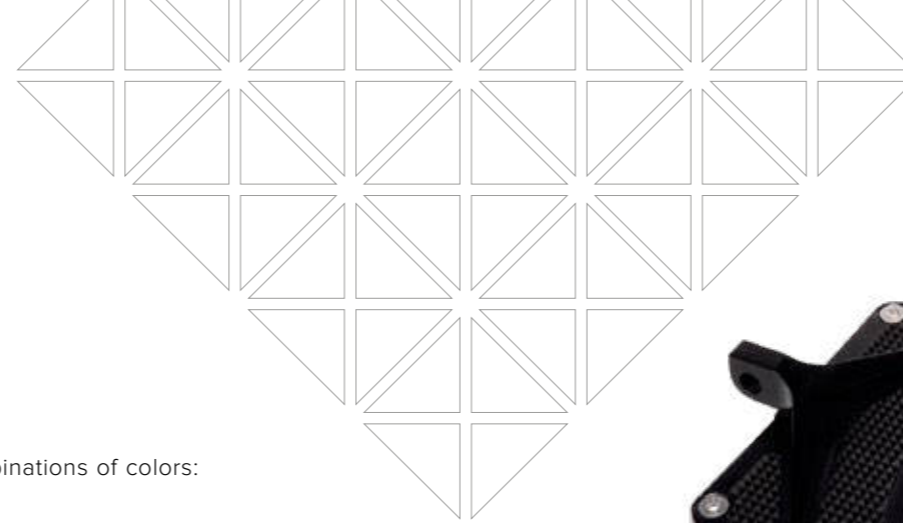

CNC Machined from billet aluminum and brass are available in a many combinations of colors: **black anodized - raw - brass - gold plated.**

16 DIAMOND Inserts provide a non-slip surface.

FEATURES:

- CNC Machined from billet aluminum or brass
- Various finishings
- Easy to install
- Made in Italy
- High Quality product

DIMENSIONS:

- Passenger Floorboards: 6.85" L x 3.25" W



◆ DFLR02BLP



◆ DFLR02CHR

DFLR02BLP	DIAMOND PASSENGER FLOORBOARD CONTRAST CUT WITH SKIDPROOF POLISHED
DFLR02CHR	DIAMOND PASSENGER FLOORBOARD FULL CHROME
DFLR02BLA	DIAMOND PASSENGER FLOORBOARD FULL BLACK WITH SKIDPROOF BLACK
DFLR02BBL	DIAMOND PASSENGER FLOORBOARD FULL BLACK WITH SKIDPROOF BLUE
DFLR02BGR	DIAMOND PASSENGER FLOORBOARD FULL BLACK WITH SKIDPROOF GREEN
DFLR02BRE	DIAMOND PASSENGER FLOORBOARD FULL BLACK WITH SKIDPROOF RED
DFLR02CBL	DIAMOND PASSENGER FLOORBOARD FULL CHROME WITH SKIDPROOF BLUE
DFLR02CGR	DIAMOND PASSENGER FLOORBOARD FULL CHROME WITH SKIDPROOF GREEN
DFLR02CRE	DIAMOND PASSENGER FLOORBOARD FULL CHROME WITH SKIDPROOF RED
DFLR02BBR	DIAMOND PASSENGER FLOORBOARD FULL BLACK WITH SKIDPROOF BRASS
DFLR02POL	DIAMOND PASSENGER FLOORBOARD FULL POLISHED WITH SKIDPROOF POLISHED
DFLR02WBR	DIAMOND PASSENGER FLOORBOARD FULL WHITE POWDEAR COAT WITH SKIDPROOF BRASS
DFLR0224K	DIAMOND PASSENGER FLOORBOARD FULL GOLD PLATED 24 KT



◆ DFLR02BLA



◆ DFLR02BBL



◆ DFLR02BGR



◆ DFLR02BRE



◆ DFLR02BBR



◆ DFLR02POL



◆ DFLR02WBR



◆ DFLR02CBL



◆ DFLR02CGR



◆ DFLR02CRE

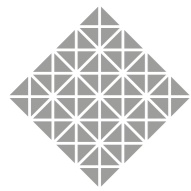

REAR PEGS

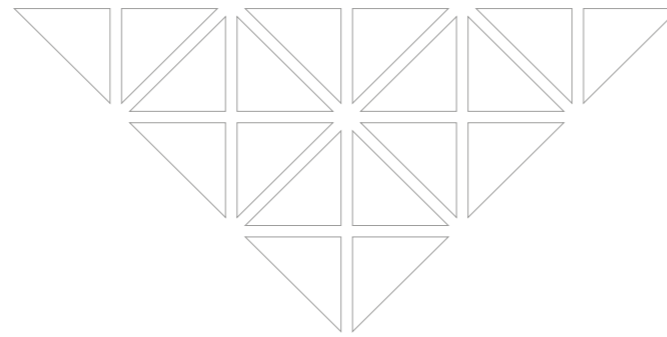

CNC Machined from billet aluminum and brass. They are very comfortable with the grips of shoes. They are made to please 3 combination: central - back - passenger. All this thanks to the fastening system pegs-pivot tube.

Made from stainless.

They are available in a many combinations of colors: black anodized - raw - brass - gold plated.

They are characterized with our Design DIAMOND.

FEATURES:

- 5 axis CNC Machined from billet aluminum or brass
- Various finishing
- Easy to install
- Made in Italy
- High Quality product

DIMENSIONS:

- Diameter 1.20"
- Length 4"

DF0001BLA	DIAMOND FOOTPEGS BLACK
DF0001CHR	DIAMOND FOOTPEGS CHROME
DF0001BRA	DIAMOND FOOTPEGS BRASS
DF0001BLU	DIAMOND FOOTPEGS BLUE
DF0001GRE	DIAMOND FOOTPEGS GREEN
DF0001RED	DIAMOND FOOTPEGS RED
DF0001POL	DIAMOND FOOTPEGS POLISHED
DF000124K	DIAMOND FOOTPEGS GOLD PLATED 24 KT

BRACKET MOUNTING PASSENGER FLOORBOARD

BRF001BLA	BRACKET MOUNTING PASSENGER FLOORBOARD/PEGS BLACK POWDEAR COAT
BRF001CHR	BRACKET MOUNTING PASSENGER FLOORBOARD/PEGS CHROME



BRF001BLA



BRF001CHR



DF0001BLA



DF0001CHR



DF0001BRA



DF0001BLU



DF0001GRE



DF0001RED



DF0001POL



DF000124K

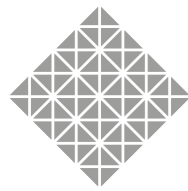

BRAKE ARM

CNC Machined from billet aluminum and brass are available in a many combinations of colors: black anodized - raw - brass - gold plated.

Brake Lever add that nice custom touch to any FL. Bike Diamond Peg offers more grip to the foot.

THEY ARE NOT AVAILABLE FOR TOURING MODELS WHICH HAS LOWER FAIRING.

FEATURES:

- 4 axes CNC Machined from billet aluminum or brass
- Various finishings
- Easy to install
- Made in Italy
- High Quality product

BRAKE ARM 97 - 07 FLT (EXCEPT FLTRU)

DBA707BPO	DIAMOND BRAKE ARM BLACK WITH POLISHED PEG
DBA707BLA	DIAMOND BRAKE ARM FULL BLACK
DBA707BBL	DIAMOND BRAKE ARM BLACK WITH BLUE PEG
DBA707BGR	DIAMOND BRAKE ARM BLACK WITH GREEN PEG
DBA707BRE	DIAMOND BRAKE ARM BLACK WITH RED PEG
DBA707BBR	DIAMOND BRAKE ARM BLACK WITH BRASS PEG
DBA707WBR	DIAMOND BRAKE ARM WHITE POWDEAR COAT WITH BRASS PEG

BRAKE ARM 08 - 13 FLT (EXCEPT FLTRU)

DBA813BPO	DIAMOND BRAKE ARM BLACK WITH POLISHED PEG
DBA813BLA	DIAMOND BRAKE ARM FULL BLACK
DBA813BBL	DIAMOND BRAKE ARM BLACK WITH BLUE PEG
DBA813BGR	DIAMOND BRAKE ARM BLACK WITH GREEN PEG
DBA813BRE	DIAMOND BRAKE ARM BLACK WITH RED PEG
DBA813BBR	DIAMOND BRAKE ARM BLACK WITH BRASS PEG
DBA813WBR	DIAMOND BRAKE ARM WHITE POWDEAR COAT WITH BRASS PEG

BRAKE ARM 14 - UP FLT (EXCEPT FLTRU)

DBA014BPO	DIAMOND BRAKE ARM BLACK WITH POLISHED PEG
DBA014BLA	DIAMOND BRAKE ARM FULL BLACK
DBA014BBL	DIAMOND BRAKE ARM BLACK WITH BLUE PEG
DBA014BGR	DIAMOND BRAKE ARM BLACK WITH GREEN PEG
DBA014BRE	DIAMOND BRAKE ARM BLACK WITH RED PEG
DBA014BBR	DIAMOND BRAKE ARM BLACK WITH BRASS PEG
DBA014WBR	DIAMOND BRAKE ARM WHITE POWDEAR COAT WITH BRASS PEG



DBA014BPO



DBA014BLA



DBA014BBL



DBA014BGR



DBA014BRE



DBA014BBR



DBA014WBR

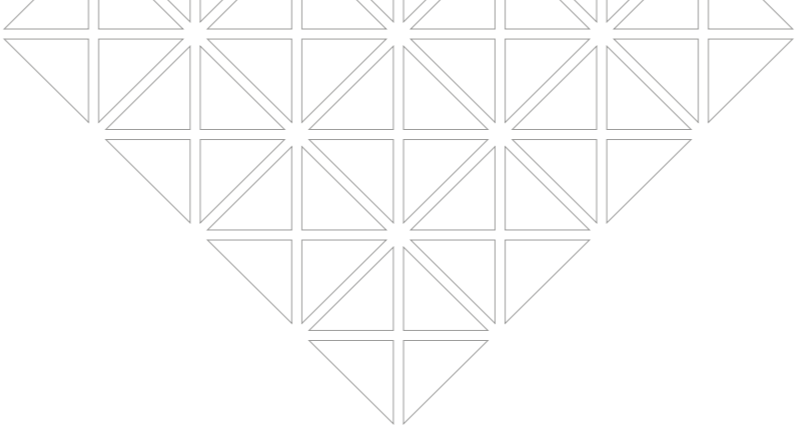

DBA014CHR



DBA014POL

BRAKE ARM 97 - 07 FLT (EXCEPT FLTRU)

DBA707CHR	DIAMOND BRAKE ARM FULL CHROME
DBA707POL	DIAMOND BRAKE ARM FULL POLISHED
DBA707CBL	DIAMOND BRAKE ARM CHROME WITH BLUE PEG
DBA707CGR	DIAMOND BRAKE ARM CHROME WITH GREEN PEG
DBA707CRE	DIAMOND BRAKE ARM CHROME WITH RED PEG
DBA707PBR	DIAMOND BRAKE ARM POLISHED WITH BRASS PEG
DBA70724K	DIAMOND BRAKE ARM GOLD PLATED 24 KT



DBA014CBL



DBA014CGR



DBA014CRE

BRAKE ARM 08 - 13 FLT (EXCEPT FLTRU)

DBA813CHR	DIAMOND BRAKE ARM FULL CHROME
DBA813POL	DIAMOND BRAKE ARM FULL POLISHED
DBA813CBL	DIAMOND BRAKE ARM CHROME WITH BLUE PEG
DBA813CGR	DIAMOND BRAKE ARM CHROME WITH GREEN PEG
DBA813CRE	DIAMOND BRAKE ARM CHROME WITH RED PEG
DBA813PBR	DIAMOND BRAKE ARM POLISHED WITH BRASS PEG
DBA81324K	DIAMOND BRAKE ARM GOLD PLATED 24 KT



DBA014PBR



DBA01424K

BRAKE ARM 14 - UP FLT (EXCEPT FLTRU)

DBA014CHR	DIAMOND BRAKE ARM FULL CHROME
DBA014POL	DIAMOND BRAKE ARM FULL POLISHED
DBA014CBL	DIAMOND BRAKE ARM CHROME WITH BLUE PEG
DBA014CGR	DIAMOND BRAKE ARM CHROME WITH GREEN PEG
DBA014CRE	DIAMOND BRAKE ARM CHROME WITH RED PEG
DBA014PBR	DIAMOND BRAKE ARM POLISHED WITH BRASS PEG
DBA01424K	DIAMOND BRAKE ARM GOLD PLATED 24 KT



HEEL / TOE SHIFT KIT

CNC Machined from billet aluminum and brass are available in a many combinations of colors: black anodized - raw - brass - gold plated.

Shift Kit add that nice custom touch to any FL. Bike Diamond Pegs offers more grip to the foot.

THEY ARE NOT AVAILABLE FOR TOURING MODELS WHICH HAS LOWER FAIRING.

FEATURES:

- 4 axes CNC Machined from billet aluminum or brass
- Various finishings
- Easy to install
- Made in Italy
- High Quality product

DHTS01BPO	DIAMOND HEEL / TOE SHIFT KIT BLACK WITH POLISHED PEGS
DHTS01BLA	DIAMOND HEEL / TOE SHIFT KIT FULL BLACK
DHTS01BBL	DIAMOND HEEL / TOE SHIFT KIT BLACK WITH BLUE PEGS
DHTS01BGR	DIAMOND HEEL / TOE SHIFT KIT BLACK WITH GREEN PEGS
DHTS01BRE	DIAMOND HEEL / TOE SHIFT KIT BLACK WITH RED PEGS
DHTS01BBR	DIAMOND HEEL / TOE SHIFT KIT BLACK WITH BRASS PEGS
DHTS01CHR	DIAMOND HEEL / TOE SHIFT KIT FULL CHROME
DHTS01POL	DIAMOND HEEL / TOE SHIFT KIT FULL POLISHED
DHTS01CBL	DIAMOND HEEL / TOE SHIFT KIT CHROME WITH BLUE PEGS
DHTS01CGR	DIAMOND HEEL / TOE SHIFT KIT CHROME WITH GREEN PEGS
DHTS01CRE	DIAMOND HEEL / TOE SHIFT KIT CHROME WITH RED PEGS
DHTS01PBR	DIAMOND HEEL / TOE SHIFT KIT POLISHED WITH BRASS PEGS
DHTS01WBR	DIAMOND HEEL / TOE SHIFT KIT WHITE POWDEAR COAT WITH BRASS PEG
DHTS0124K	DIAMOND HEEL / TOE SHIFT KIT FULL GOLD PLATED 24 KT



DHTS01WBR



DHTS0124K



DHTS01BPO



DHTS01CHR



DHTS01BLA



DHTS01POL



DHTS01BBL



DHTS01CBL



DHTS01BGR



DHTS01CGR



DHTS01BRE



DHTS01CRE



DHTS01BBR



DHTS01PBR

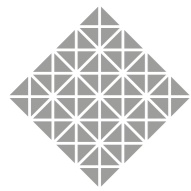

SHIFT RODS

CNC Machined from billet aluminum and brass are available in a many combinations of colors: black anodized - raw - brass - gold plated.

To make precious our products we are fitting a DIAMOND Gem.

FEATURES:

- 5 axis CNC Machined from billet aluminum or brass
- Various finishings
- Easy to install
- Made in Italy
- High Quality product
- Available HARLEY-DAVIDSON 86-18 Softail FXS, FXST, FLS, FLST, 84-18 FLT/Touring

DSR001BPO	DIAMOND SHIFT ROD BLACK WITH POLISHED DIAMOND
DSR001BLA	DIAMOND SHIFT ROD FULL BLACK
DSR001BBL	DIAMOND SHIFT ROD BLACK WITH BLUE DIAMOND
DSR001BGR	DIAMOND SHIFT ROD BLACK WITH GREEN DIAMOND
DSR001BRE	DIAMOND SHIFT ROD BLACK WITH RED DIAMOND
DSR001BBR	DIAMOND SHIFT ROD BLACK WITH BRASS DIAMOND
DSR001CHR	DIAMOND SHIFT ROD FULL CHROME
DSR001POL	DIAMOND SHIFT ROD FULL POLISHED
DSR001CBL	DIAMOND SHIFT ROD CHROME WITH BLUE DIAMOND
DSR001CGR	DIAMOND SHIFT ROD CHROME WITH GREEN DIAMOND
DSR001CRE	DIAMOND SHIFT ROD CHROME WITH RED DIAMOND
DSR001PBR	DIAMOND SHIFT ROD POLISHED WITH BRASS DIAMOND
DSR001WBR	DIAMOND SHIFT ROD WHITE POWDEAR COAT WITH BRASS DIAMOND
DSR00124K	DIAMOND SHIFT ROD FULL GOLD PLATE 24 KT



DSR001WBR



DSR00124K



DSR001BPO



DSR001CHR



DSR001BLA



DSR001POL



DSR001BBL



DSR001CBL



DSR001BGR



DSR001CGR



DSR001BRE



DSR001CRE



DSR001BBR



DSR001PBR



SADDLEBAG LATCH COVER 2014 UP & DOWN

CNC Machined from billet aluminum are available in a many combinations of colors: black anodized - raw - polished - contrast cut.

They are characterized with our Design DIAMOND.

FEATURES:

- 5 axis CNC Machined from billet aluminum or brass
- Various finishings
- Easy to install
- Made in Italy
- High Quality product
- Available HARLEY-DAVIDSON TOURING 2014 UP & DOWN

SADDLEBAG LATCH COVER 2014 UP

DSL14UBLA	DIAMOND SADDLEBAG LATCH COVER FULL BLACK
DSL14UCHR	DIAMOND SADDLEBAG LATCH COVER CHROME
DSL14UCUT	DIAMOND SADDLEBAG LATCH COVER CONTRAST CUT
DSL14UPOL	DIAMOND SADDLEBAG LATCH COVER POLISHED
DSL14UWHT	DIAMOND SADDLEBAG LATCH COVER WHITE POWDEAR COAT
DSL14U24K	DIAMOND SADDLEBAG LATCH FULL GOLD PLATED 24 KT

SADDLEBAG LATCH COVER 2014 DOWN

DSL14DBLA	DIAMOND SADDLEBAG LATCH COVER FULL BLACK
DSL14DCHR	DIAMOND SADDLEBAG LATCH COVER CHROME
DSL14DCUT	DIAMOND SADDLEBAG LATCH COVER CONTRAST CUT
DSL14DPOL	DIAMOND SADDLEBAG LATCH COVER POLISHED
DSL14DWHT	DIAMOND SADDLEBAG LATCH COVER WHITE POWDEAR COAT
DSL14D24K	DIAMOND SADDLEBAG LATCH FULL GOLD PLATED 24 KT



DSL14UBLA



DSL14UCHR



DSL14UCUT

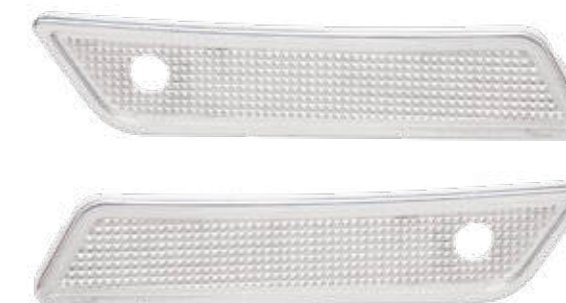

DSL14UPOL

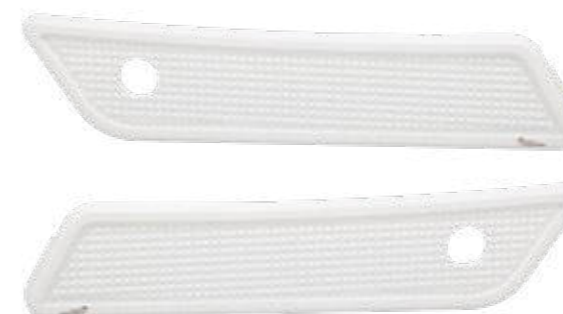

DSL14UWHT



DSL14U24K

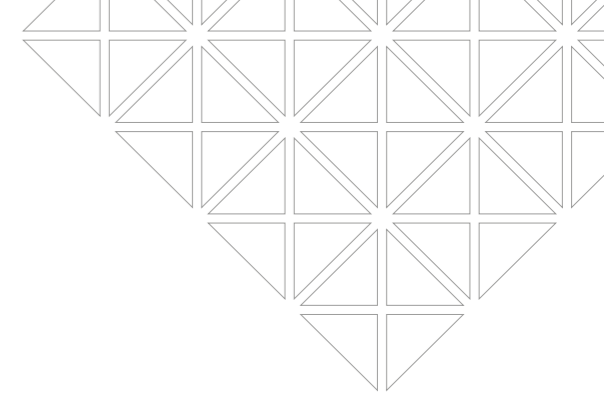
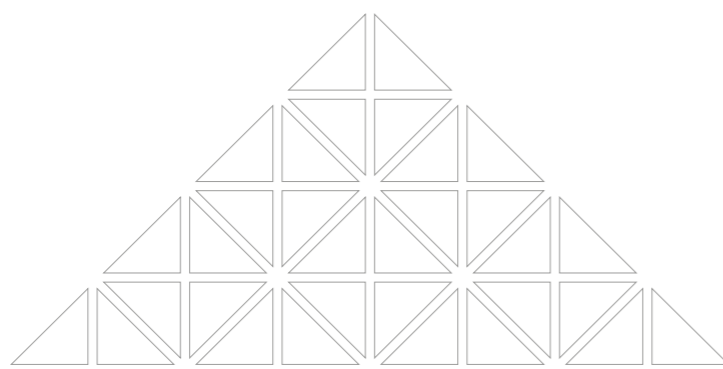



DERBY/POINT COVER

CNC Machined from billet aluminum are available in a many combinations of colors: black anodized - raw - gold plated.

DIAMOND Design leaves a clean look to the engine.

Available Milwaukee 8.

FEATURES:

- CNC Machined from billet aluminum
- Various finishings
- Easy to install
- Made in Italy
- High Quality product
- Available HARLEY-DAVIDSON DYNA 2006 UP
- Available HARLEY-DAVIDSON Touring and Softail Models

DIAMOND DERBY COVER 2016 UP

DDC16UBLA	DIAMOND DERBY COVER BLACK
DDC16UCHR	DIAMOND DERBY COVER CHROME
DDC16UPOL	DIAMOND DERBY COVER POLISHED
DDC16UWHT	DIAMOND DERBY COVER WHITE POWDEAR COAT
DDC16U24K	DIAMOND DERBY COVER GOLD PLATED 24 KT

DIAMOND DERBY COVER 2016 DOWN

DDC16DBLA	DIAMOND DERBY COVER BLACK
DDC16DCHR	DIAMOND DERBY COVER CHROME
DDC16DPOL	DIAMOND DERBY COVER POLISHED
DDC16DWHT	DIAMOND DERBY COVER WHITE POWDEAR COAT
DDC16D24K	DIAMOND DERBY COVER GOLD PLATED 24 KT

DIAMOND POINT COVER

DPC001BLA	DIAMOND POINT COVER BLACK
DPC001CHR	DIAMOND POINT COVER CHROME
DPC001POL	DIAMOND POINT COVER POLISHED
DPC001BRA	DIAMOND POINT COVER BRASS
DPC00124K	DIAMOND POINT COVER GOLD PLATED 24 KT

DIAMOND POINT COVER MILWAUKEE 8

DPC001BLA-M	DIAMOND POINT COVER BLACK
DPC001CHR-M	DIAMOND POINT COVER CHROME
DPC001POL-M	DIAMOND POINT COVER POLISHED
DPC001BRA-M	DIAMOND POINT COVER BRASS
DPC00124K-M	DIAMOND POINT COVER GOLD PLATED 24 KT

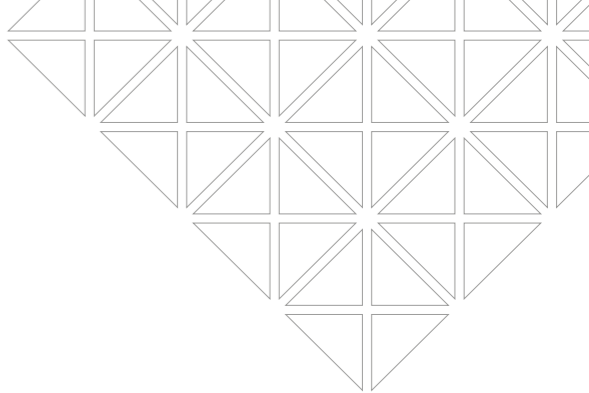

DDC16DBLA

DPC001BLA



DDC16DCHR

DPC001CHR



DDC16DPOL

DPC001POL



DDC16D24K

DPC00124K



DPC001BRA

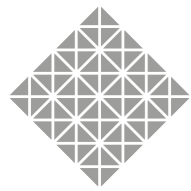

FRONT TURN SIGNAL BAR

CNC Machined from billet aluminum and brass are available in a many combinations of colors: black anodized - raw - brass - gold plated.

Six High brightness LED integrated into the body, equipped with European approval. They could be used for Harley Davidson Touring Model - Road King.

FEATURES:

- 5 axis CNC Machined from billet aluminum or brass
- Various finishings
- Easy to install
- Made in Italy
- High Quality product
- Six High brightness LED

DTS001BPO	DIAMOND FRONT TURN SIGNAL BLACK RING POLISHED
DTS001POL	DIAMOND FRONT TURN SIGNAL FULL POLISHED
DTS001BLA	DIAMOND FRONT TURN SIGNAL FULL BLACK
DTS001BBL	DIAMOND FRONT TURN SIGNAL BLACK RING BLUE
DTS001BGR	DIAMOND FRONT TURN SIGNAL BLACK RING GREEN
DTS001BRE	DIAMOND FRONT TURN SIGNAL BLACK RING RED
DTS001BBR	DIAMOND FRONT TURN SIGNAL BLACK RING BRASS
DTS001CHR	DIAMOND FRONT TURN SIGNAL FULL CHROME
DTS001CBL	DIAMOND FRONT TURN SIGNAL CHROME RING BLUE
DTS001CGR	DIAMOND FRONT TURN SIGNAL CHROME RING GREEN
DTS001CRE	DIAMOND FRONT TURN SIGNAL CHROME RING RED
DTS001PBR	DIAMOND FRONT TURN SIGNAL POLISHED RING BRASS
DTS001WBR	DIAMOND FRONT TURN SIGNAL WHITE POWDEAR COAT RING BRASS
DTS00124k	DIAMOND FRONT TURN SIGNAL FULL GOLD PLATED 24 KT



DTS001BPO



DTS001POL



DTS001CHR



DTS001BBL



DTS001BGR



DTS001BRE



DTS001BLA



DTS001BBR



DTS001PBR



DTS001CBL



DTS001CGR



DTS001CRE

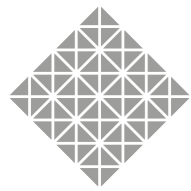

TAIL LIGHTS

CNC Machined from billet aluminum and brass are available in a many combinations of colors: black anodized raw - brass - gold plated.

DIAMOND Design Tail lights are the perfect fit for your rear fender or the back of your saddlebags.

FEATURES:

- 5 axis CNC Machined from billet aluminum or brass
- Various finishings
- Easy to install
- Made in Italy
- High Quality product
- 12 High brightness LED

DIMENSIONS:

- Tail lights: 5.20" L x 2.15" W

DTL001BPO	DIAMOND TAIL LIGHT BLACK RING POLISHED
DTL001POL	DIAMOND TAIL LIGHT FULL POLISHED
DTL001BLA	DIAMOND TAIL LIGHT FULL BLACK
DTL001BBL	DIAMOND TAIL LIGHT BLACK RING BLUE
DTL001BGR	DIAMOND TAIL LIGHT BLACK RING GREEN
DTL001BRE	DIAMOND TAIL LIGHT BLACK RING RED
DTL001BBR	DIAMOND TAIL LIGHT BLACK RING BRASS
DTL001CHR	DIAMOND TAIL LIGHT FULL CHROME
DTL001CBL	DIAMOND TAIL LIGHT CHROME RING BLUE
DTL001CGR	DIAMOND TAIL LIGHT CHROME RING GREEN
DTL001CRE	DIAMOND TAIL LIGHT CHROME RING RED
DTL001PBR	DIAMOND TAIL LIGHT POLISHED RING BRASS
DTL001WBR	DIAMOND TAIL LIGHT WHITE POWDEAR COAT RING BRASS
DTL00124k	DIAMOND TAIL LIGHT FULL GOLD PLATED 24 KT



DTL001BPO



DTL001CHR



DTL001BBL



DTL001BGR



DTL001BRE



DTL001BBR



DTL001BLA



DTL001POL



DTL001WBR



DTL001CBL



DTL001CGR



DTL001CRE



DTL001PBR

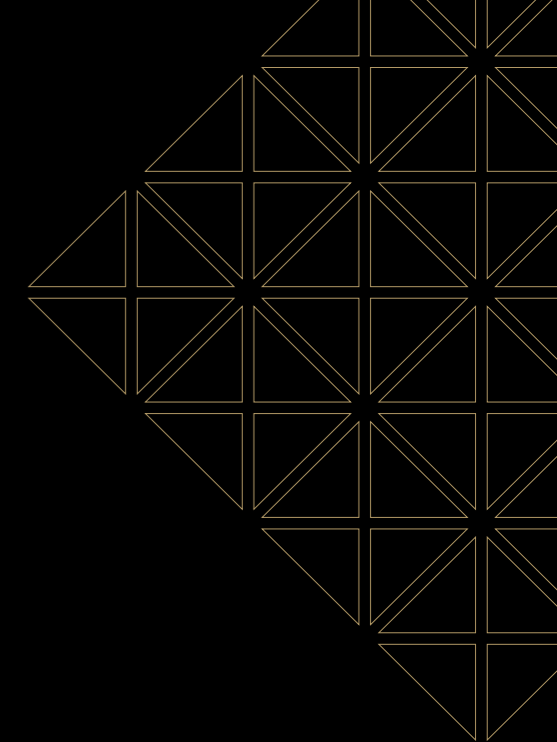

24kt Gold Collection

Always looking for new shapes / lines / colors.

Everytime we are around on the boutiques in the major fashion cities in Italy such as Milan, Rome, Florence where we could find some suggestions that can distinguish us from other brands of motorcycle accessories.

For a few years in the fashion and apparel clothing a luxurious material prevails "The GOLD".
Why not use this luxury material this color in our collections.

"Who has everything to need something more, or you distinguish or extinguish".



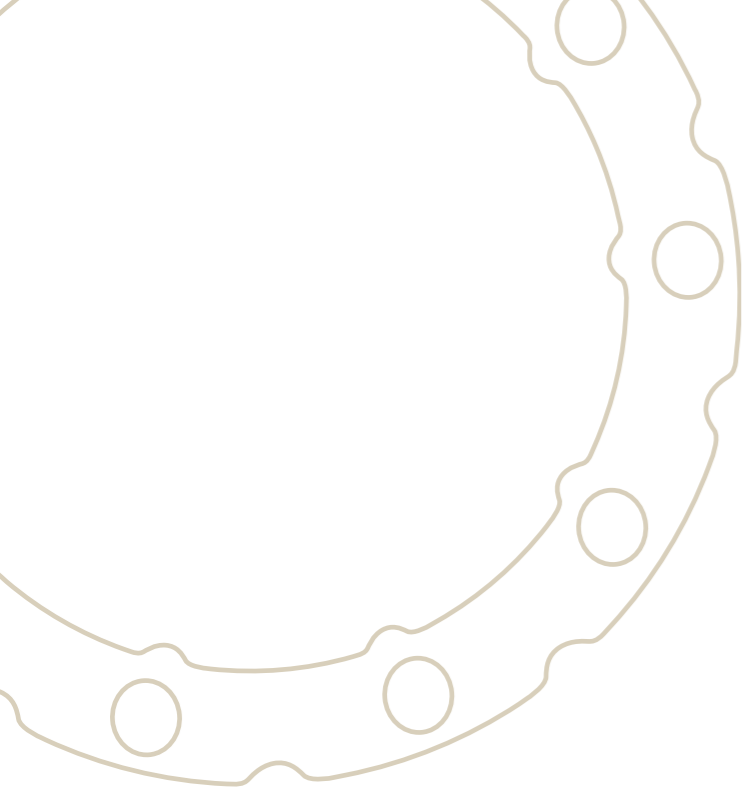

JUICER FRONT LIGHT 24KT



JUICER AIRCLEANER 24KT



JUICER TAILLIGHT 24KT



VELOCITY STACK GRILL DESIGN 24KT



JUICER TURN SIGNAL 24KT



VELOCITY STACK CHALLENGER DESIGN 24KT

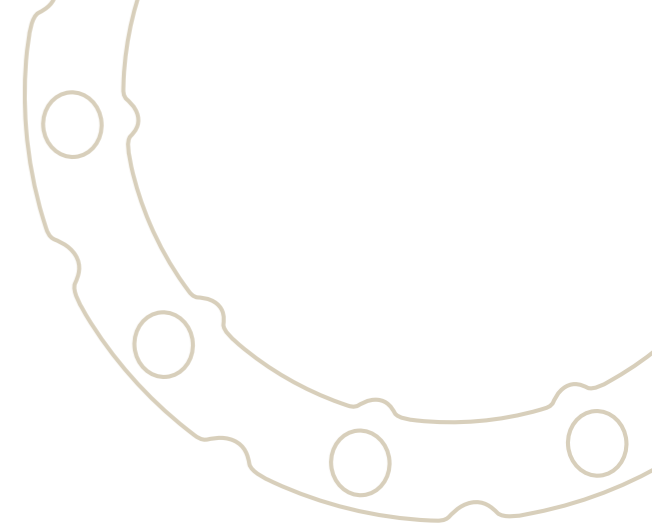

GRIPS 24KT



GRILL MIRROR 24KT



SHARIF FOOTPEGS 24KT



SHARIF SHIFT / BRAKE PEG 24KT



SHARIF GAS CAP 24KT

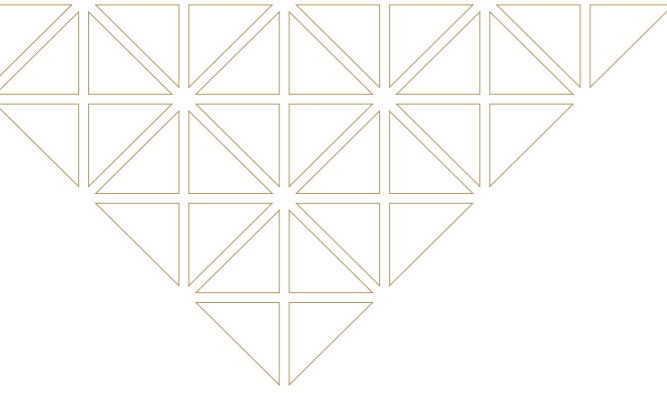

DIAMOND FRONT FLOORBOARD 24KT



DIAMOND BRAKE ARM 24KT



DIAMOND PEGS 24KT



DIAMOND HEEL / TOE SHIFT 24KT

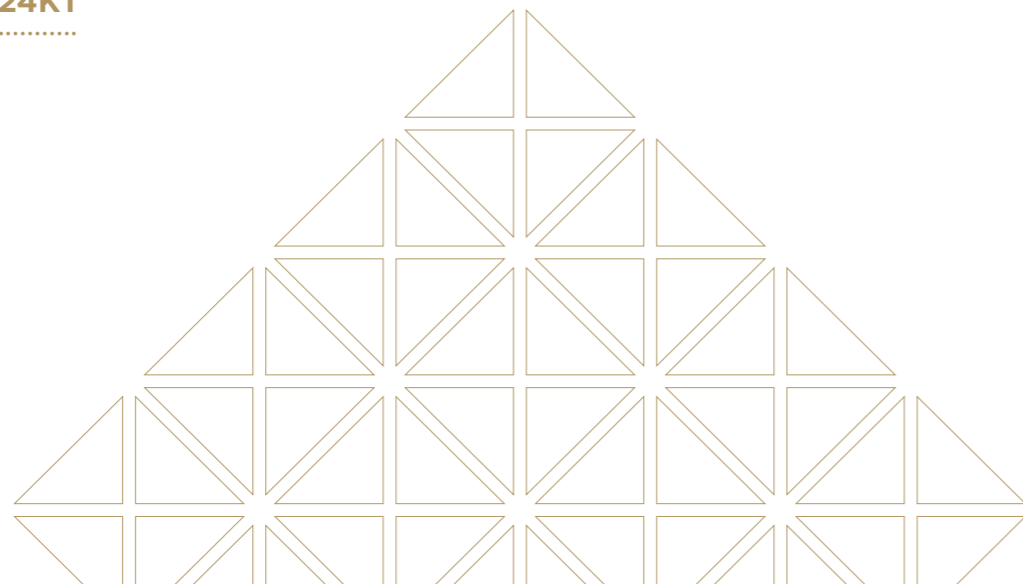

DIAMOND SHIFT ROD 24KT

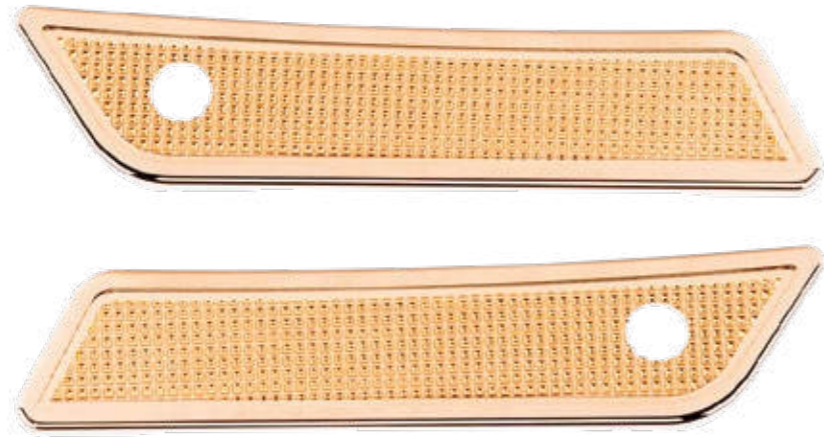

DIAMOND SADDLEBAG LATCH COVER 24KT



DIAMOND DERBY COVER 24KT



DIAMOND POINT COVER 24KT

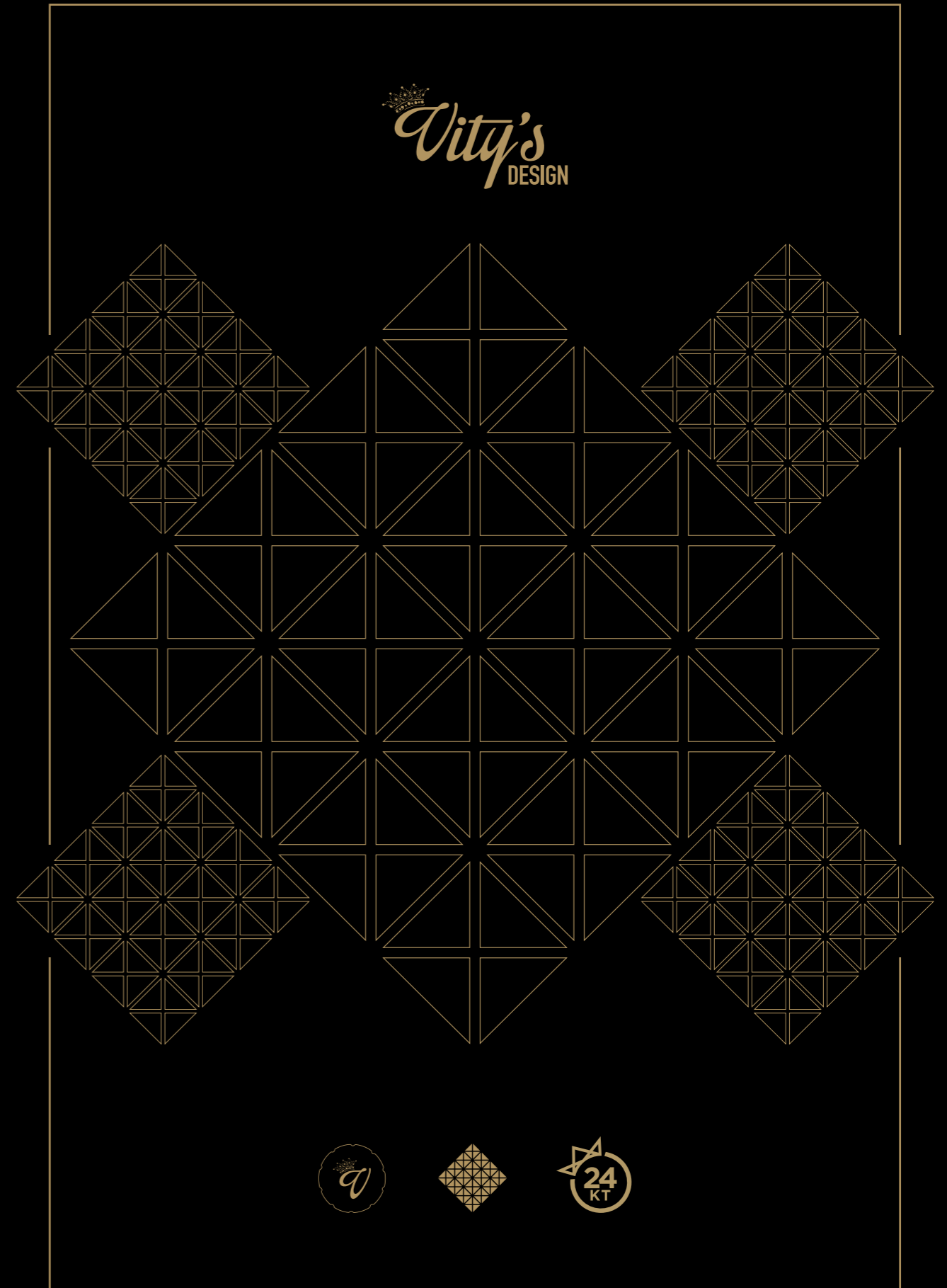



ITALIAN CRAFTSMANSHIP

+39 329.2006128

info@vitydesign.com

shop.vitydesign.com



VITYSDESIGN.COM